

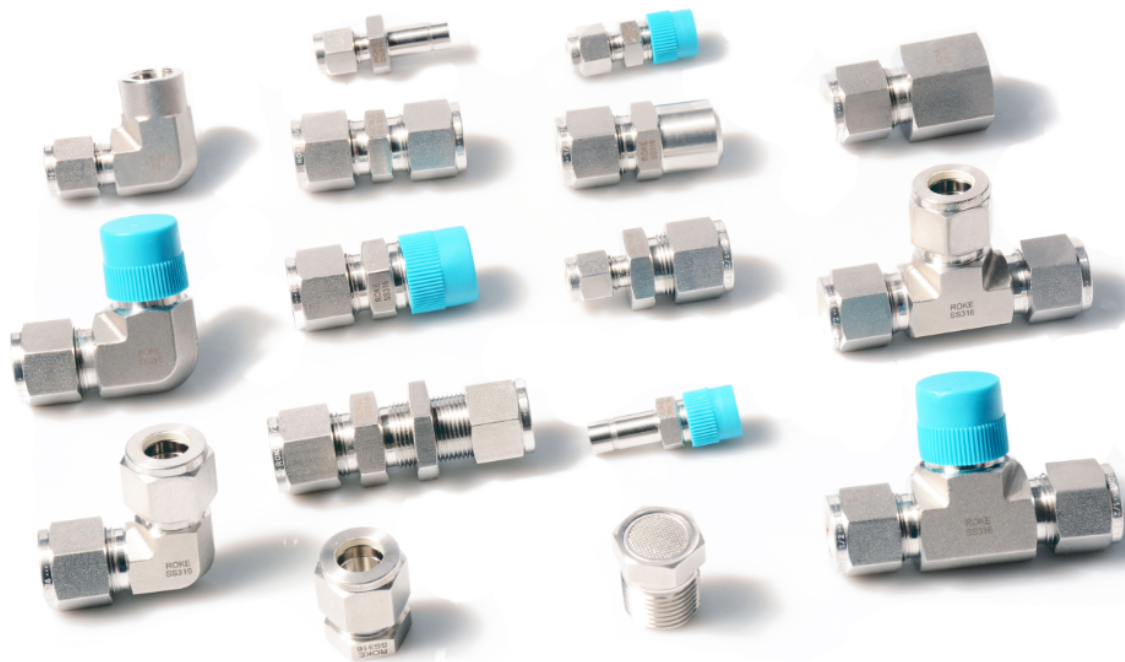

Tube Fittings







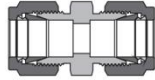
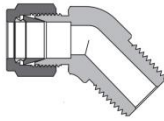
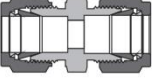
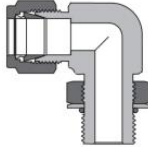
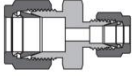
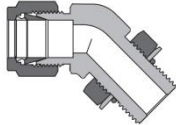
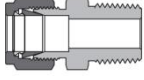
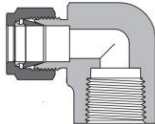
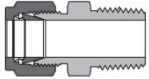
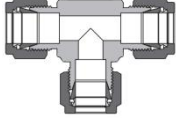
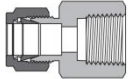
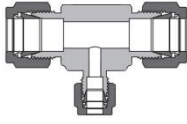
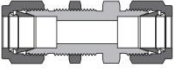
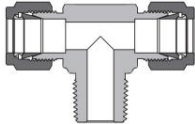
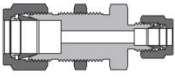
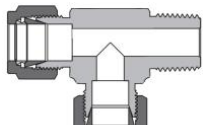
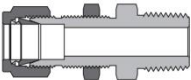
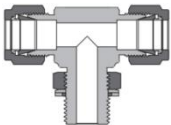
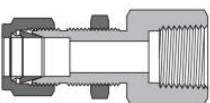
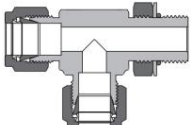

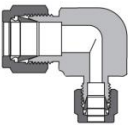
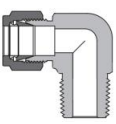

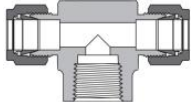
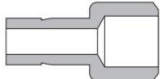
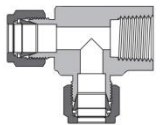
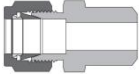
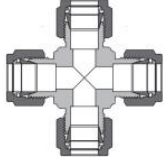
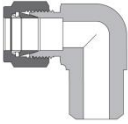

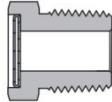

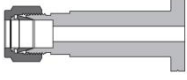
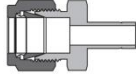
ROKE
Valves and Fittings

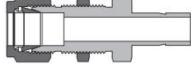
www.chinaroke.com

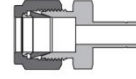
Contents

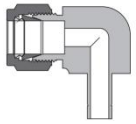
Unions - TU	01		45° Male Elbows - MV	28		
Conversion Unions - CU	02		Adjustable Male Elbows - AME	29		
Reducing Unions - RU	03		45° Adjustable Male Elbows - AMV	30		
Male Connectors - MC	04		14	Female Elbows - FE	31	
Thermocouple Connectors - TC	14		15	Union Tees - UT	32	
Female Connectors - CF	15		20	Reducing Union Tees - RUT	33	
Bulkhead Unions - BU	20		21	Male Branch Tees - MBT	35	
Bulkhead Reducing Unions - BRU	21		22	Male Run Tees - MRT	36	
Bulkhead Male Connectors - BMC	22		23	Adjustable Male Branch Tees - AMB	37	
Bulkhead Female Connectors - BFC	23		24	Adjustable Male Run Tees - AMR	38	
Union Elbows - UE	24		25			
Union Reducing Elbows - URE	25		26			
Male Elbows - ME	26					

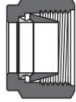
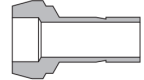
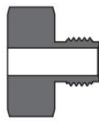
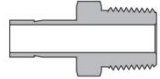
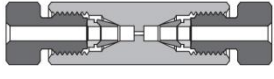
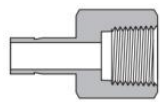
Female Branch Tees - FBT	39	Weld Adapters - WAD	56
			
Female Run Tees - FRTT	40	Weld Connectors - WDC	56
			
Union Crosses - UC	41	Weld Elbows - WDE	58
			
Caps - TC	42	Vent Protectors - VP	59
			
Plugs - TP	43	Lapped Flange Connectors - LFC	59
			
Reducers - RD	44	Flange Adapters - FGA	60
			
Bulkhead Reducers - BR	46	Nuts - TN	61
			
Reducer - RD	46	Front Ferrules - FF	61
			
Reducer Elbows - RDE	47	Rear Ferrules - RF	61
			
Port Connectors - RPC	47	Nuts + Ferrules - NF	62
			
Reducing Port Connectors - RPC	48	Male Nuts - MN	62
			
Male Adapters - MAD	49	Chromatograph Fittings - CU	63
			
Female Adapters - FAD	53		
			

Installation Instructions

Tube Fittings Up to 1 in./25 mm

These instructions apply both to traditional fittings and to fittings with the advanced back-ferrule geometry.

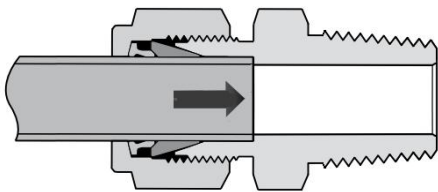
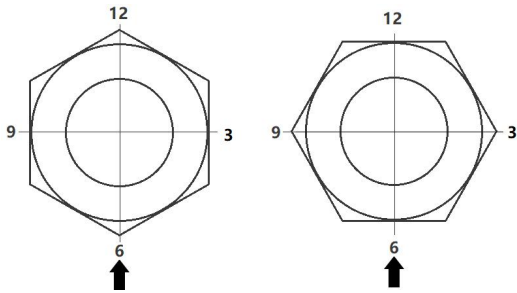
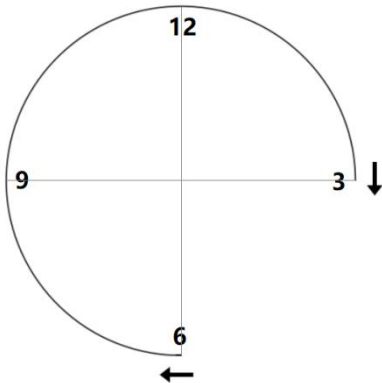
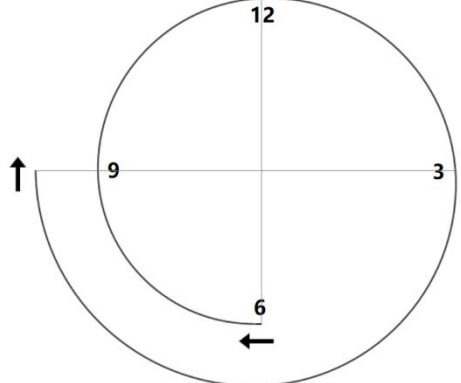
 <p>Fully insert the tube into the fitting and against the shoulder; rotate the nut finger-tight.</p>	 <p>Mark the nut at the 6 o'clock position.</p>
 <p>1/16, 1/8, and 3/16 in.; 2, 3, and 4 mm tube fittings, tighten the nut only three-quarters turn to the 3 o'clock position.</p>	 <p>1/4 to 1 inch., and 6mm to 25 mm tube fittings, tighten the nut one and one-quarters turn to the 9 o'clock position.</p>

Tube Fittings Over 1 in./25 mm

1. Preswage the ferrules onto the tube using the Multihead Hydraulic Swaging Unit (MHSU).
2. Apply the lubricant lightly to the body threads and the rear surface of the back ferrule.
3. Insert the tube with preswaged ferrules into the fitting until the front ferrule seats against the fitting body; rotate the nut finger-tight.
4. Mark the nut at the 6 o'clock position.
5. While holding the fitting body steady, tighten the nut one-half turn to the 12 o'clock position.

Reassembly-All Sizes

You may disassemble and reassemble tube fittings many times. Always depressurize the system before disassembling. Prior to disassembly, mark a line long the nut and fitting body flats. Use the marks to ensure that you return the nut to the previously pulled-up position.

Insert the tube with preswaged ferrules into the fitting until the front ferrule seats against the fitting body.

While holding the fitting body steady, rotate the nut with a wrench to the previously pulled-up position, as indicated by the marks on the tube and flats. At this point, you will feel a significant increase in resistance. Tighten the nut slightly.

1 Tube Fittings

Unions

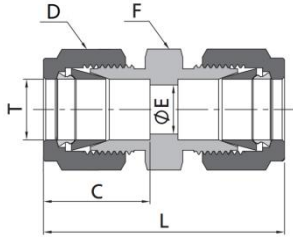

Fractional Tube

T-Tube O.D. (in.)	Basic Ordering Number	Dimension, in(mm)				
		L	C	D	F	E
1/16	-TU-FT1	0.99(25.1)	0.34(8.6)	0.31(7.9)	0.44(11.1)	0.05(1.3)
1/8	-TU-FT2	1.40(35.6)	0.50(12.7)	0.44(11.1)	0.44(11.1)	0.09(2.3)
3/16	-TU-FT3	1.47(37.3)	0.54(13.7)	0.50(12.7)	0.50(12.7)	0.12(3.0)
1/4	-TU-FT4	1.61(40.9)	0.60(15.2)	0.56(14.3)	0.50(12.7)	0.19(4.8)
5/16	-TU-FT5	1.69(42.9)	0.64(16.2)	0.63(15.9)	0.56(14.3)	0.25(6.4)
3/8	-TU-FT6	1.77(45.0)	0.66(16.8)	0.69(17.5)	0.63(15.9)	0.28(7.1)
1/2	-TU-FT8	2.02(51.3)	0.90(22.9)	0.87(22.2)	0.81(20.6)	0.41(10.4)
5/8	-TU-FT10	2.05(52.1)	0.96(24.4)	1.00(25.4)	0.94(23.9)	0.50(12.7)
3/4	-TU-FT12	2.11(53.6)	0.96(24.4)	1.13(28.6)	1.06(27.0)	0.62(15.7)
7/8	-TU-FT14	2.17(55.1)	1.02(25.9)	1.25(31.8)	1.37(34.9)	0.72(18.3)
1	-TU-FT16	2.55(64.8)	1.23(31.2)	1.5(38.1)	1.37(34.9)	0.88(22.4)
1 1/8	-TU-FT18	2.55(64.8)	1.23(31.2)	1.75(44.5)	1.63(41.3)	0.97(24.6)
1 1/4	-TU-FT20	3.63(92.2)	1.62(41.1)	1.87(47.6)	1.75(44.5)	1.09(27.7)
1 1/2	-TU-FT24	4.25(108.0)	1.97(50.0)	2.25(57.2)	2.13(54.0)	1.34(34.0)

Metric Tube

T-Tube O.D. (mm)	Basic Ordering Number	Dimension, mm(in.)				
		L	C	D	F	E
2	-TU-MT2	35.6(1.40)	12.9(0.51)	12.0(0.47)	12.0(0.47)	1.7(0.07)
3	-TU-MT3	35.3(1.39)	12.9(0.51)	12.0(0.47)	12.0(0.47)	2.4(0.09)
4	-TU-MT4	37.3(1.47)	13.7(0.54)	12.0(0.47)	12.0(0.47)	2.4(0.09)
6	-TU-MT6	41.0(1.61)	15.3(0.60)	14.0(0.55)	14.0(0.55)	4.8(0.19)
8	-TU-MT8	43.2(1.70)	16.2(0.64)	16.0(0.63)	15.0(0.59)	6.4(0.25)
10	-TU-MT10	46.2(1.82)	17.2(0.68)	19.0(0.75)	18.0(0.71)	7.9(0.31)
12	-TU-MT12	51.2(2.02)	22.8(0.90)	22.0(0.87)	22.0(0.87)	9.5(0.37)
14	-TU-MT14	52.0(2.05)	24.4(0.96)	25.0(0.98)	24.0(0.94)	11.1(0.44)
15	-TU-MT15	52.0(2.05)	24.4(0.96)	25.0(0.98)	24.0(0.94)	11.9(0.47)
16	-TU-MT16	52.0(2.05)	24.4(0.96)	25.0(0.98)	24.0(0.94)	12.7(0.50)
18	-TU-MT18	53.5(2.11)	24.4(0.96)	30.0(1.18)	27.0(1.06)	15.1(0.59)
20	-TU-MT20	55.0(2.17)	26.0(1.02)	32.0(1.26)	30.0(1.18)	15.9(0.63)
22	-TU-MT22	55.0(2.17)	26.0(1.02)	32.0(1.26)	30.0(1.18)	18.3(0.72)
25	-TU-MT25	65.0(2.56)	31.3(1.23)	38.0(1.50)	35.0(1.38)	21.8(0.86)
28	-TU-MT28	85.0(3.35)	36.6(1.44)	46.0(1.81)	41.0(1.61)	21.8(0.86)
30	-TU-MT30	92.7(3.65)	39.6(1.56)	50.0(1.97)	46.0(1.81)	26.2(1.03)
32	-TU-MT32	97.3(3.83)	42.0(1.65)	50.0(1.97)	46.0(1.81)	28.6(1.13)
38	-TU-MT38	113.6(4.47)	49.4(1.94)	60.0(2.36)	55.0(2.17)	33.7(1.33)

2 Tube Fittings

Conversion Unions

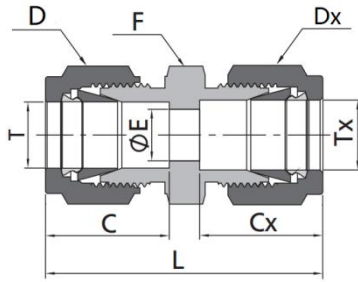

Metric Tube to Fractional Tube

T-Tube O.D. (mm)	Tx-Tube O.D. (in.)	Basic Ordering Number	Dimension, in(mm)						
			L	C	D	F	E	Cx	Dx
3	1/8	-CU-MT3-FT2	35.2(1.39)	12.9(0.51)	12.0(0.47)	12.0(0.47)	2.4(0.09)	12.7(0.50)	11.1(0.44)
4	1/8	-CU-MT4-FT2	36.5(1.44)	13.7(0.54)	12.0(0.47)	12.0(0.47)	2.4(0.09)	12.7(0.50)	11.1(0.44)
4	1/4	-CU-MT4-FT4	39.4(1.55)	13.7(0.54)	12.0(0.47)	14.0(0.55)	2.4(0.09)	15.2(0.60)	14.3(0.56)
6	1/8	-CU-MT6-FT2	38.5(1.52)	15.3(0.60)	14.0(0.55)	14.0(0.55)	2.4(0.09)	12.7(0.50)	11.1(0.44)
6	1/4	-CU-MT6-FT4	41.0(1.61)	15.3(0.60)	14.0(0.55)	14.0(0.55)	4.8(0.19)	15.2(0.60)	14.3(0.56)
6	5/16	-CU-MT6-FT5	42.3(1.67)	15.3(0.60)	14.0(0.55)	14.0(0.55)	4.8(0.19)	16.2(0.64)	15.9(0.63)
8	1/4	-CU-MT8-FT4	42.3(1.67)	16.2(0.64)	16.0(0.63)	15.0(0.59)	4.8(0.19)	15.2(0.60)	14.3(0.56)
8	3/8	-CU-MT8-FT6	44.3(1.74)	16.2(0.64)	16.0(0.63)	16.0(0.63)	6.4(0.25)	16.8(0.66)	17.5(0.69)
10	1/8	-CU-MT10-FT2	41.8(1.65)	17.2(0.68)	19.0(0.75)	18.0(0.71)	2.4(0.09)	12.7(0.50)	11.1(0.44)
10	1/4	-CU-MT10-FT4	44.5(1.75)	17.2(0.68)	19.0(0.75)	18.0(0.71)	4.8(0.19)	15.2(0.60)	14.3(0.56)
10	5/16	-CU-MT10-FT5	45.1(1.78)	17.2(0.68)	19.0(0.75)	18.0(0.71)	6.4(0.25)	16.2(0.64)	15.9(0.63)
10	3/8	-CU-MT10-FT6	45.9(1.81)	17.2(0.68)	19.0(0.75)	18.0(0.71)	7.1(0.28)	16.8(0.66)	17.5(0.69)
12	5/16	-CU-MT12-FT5	47.8(1.88)	22.8(0.90)	22.0(0.87)	22.0(0.87)	6.4(0.25)	16.2(0.64)	15.9(0.63)
12	3/8	-CU-MT12-FT6	48.4(1.91)	22.8(0.90)	22.0(0.87)	22.0(0.87)	7.1(0.28)	16.8(0.66)	17.5(0.69)
12	1/2	-CU-MT12-FT8	51.2(2.02)	22.8(0.90)	22.0(0.87)	22.0(0.87)	9.5(0.37)	22.9(0.90)	22.2(0.87)
15	1/2	-CU-MT15-FT8	52.0(2.05)	24.4(0.96)	25.0(0.98)	24.0(0.94)	10.4(0.41)	22.9(0.90)	22.2(0.87)
16	5/8	-CU-MT16-FT10	52.0(2.05)	24.4(0.96)	25.0(0.98)	24.0(0.94)	12.7(0.50)	24.4(0.96)	25.4(1.00)
18	3/4	-CU-MT18-FT12	53.5(2.11)	24.4(0.96)	30.0(1.18)	27.0(1.06)	15.1(0.59)	24.4(0.96)	28.6(1.13)
20	1/2	-CU-MT20-FT8	55.0(2.17)	26.0(1.02)	32.0(1.26)	30.0(1.18)	10.4(0.41)	22.9(0.90)	22.2(0.87)
20	1	-CU-MT20-FT16	62.8(2.47)	26.0(1.02)	32.0(1.26)	35.0(1.38)	15.9(0.63)	31.2(1.23)	38.1(1.50)
25	1	-CU-MT25-FT16	65.0(2.56)	31.3(1.23)	38.0(1.50)	35.0(1.38)	21.8(0.86)	31.2(1.23)	38.1(1.50)
28	1	-CU-MT28-FT16	79.6(3.13)	36.6(1.44)	46.0(1.81)	41.0(1.61)	21.8(0.86)	31.2(1.23)	38.1(1.50)
30	1	-CU-MT32-FT16	85.3(3.35)	39.6(1.56)	50.0(1.97)	46.0(1.81)	21.8(0.86)	31.2(1.23)	38.1(1.50)
32	1	-CU-MT32-FT16	86.5(3.40)	42.0(1.65)	50.0(1.97)	46.0(1.81)	21.8(0.86)	31.2(1.23)	38.1(1.50)
38	1	-CU-MT38-FT16	95.4(3.76)	49.4(1.94)	60.0(2.36)	55.0(2.17)	21.8(0.86)	31.2(1.23)	38.1(1.50)

3 Tube Fittings

Reducing Unions

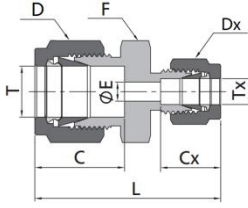

Fractional Tube									
T-Tube O.D. (in.)	Tx-Tube O.D. (in.)	Basic Ordering Number	Dimension, in(mm)						
			L	C	D	F	E	Cx	Gx
1/8	1/16	-RU-FT2-FT1	1.22(31.0)	0.50(12.7)	0.44(11.1)	0.44(11.1)	0.05(1.3)	0.34(8.6)	0.31(7.9)
3/16	1/16	-RU-FT3-FT1	1.27(32.3)	0.54(13.7)	0.50(12.7)	0.44(11.1)	0.05(1.3)	0.34(8.6)	0.31(7.9)
3/16	1/8	-RU-FT3-FT2	1.44(36.6)	0.54(13.7)	0.50(12.7)	0.44(11.1)	0.09(2.3)	0.50(12.7)	0.44(11.1)
1/4	1/16	-RU-FT4-FT1	1.35(34.3)	0.60(15.2)	0.56(14.3)	0.50(12.7)	0.05(1.3)	0.34(8.6)	0.31(7.9)
1/4	1/8	-RU-FT4-FT2	1.52(38.6)	0.60(15.2)	0.56(14.3)	0.50(12.7)	0.09(2.3)	0.50(12.7)	0.44(11.1)
1/4	3/16	-RU-FT4-FT3	1.55(39.4)	0.60(15.2)	0.56(14.3)	0.50(12.7)	0.12(3.0)	0.54(13.7)	0.50(12.7)
5/16	1/8	-RU-FT5-FT2	1.56(39.6)	0.64(16.2)	0.63(15.9)	0.56(14.3)	0.09(2.3)	0.50(12.7)	0.44(11.1)
5/16	1/4	-RU-FT5-FT4	1.66(42.2)	0.64(16.2)	0.63(15.9)	0.56(14.3)	0.19(4.8)	0.60(15.2)	0.56(14.3)
3/8	1/16	-RU-FT6-FT1	1.44(36.6)	0.66(16.8)	0.69(17.5)	0.63(15.9)	0.05(1.3)	0.34(8.6)	0.31(7.9)
3/8	1/8	-RU-FT6-FT2	1.61(40.9)	0.66(16.8)	0.69(17.5)	0.63(15.9)	0.09(2.3)	0.50(12.7)	0.44(11.1)
3/8	1/4	-RU-FT6-FT4	1.70(43.2)	0.66(16.8)	0.69(17.5)	0.63(15.9)	0.19(4.8)	0.60(15.2)	0.56(14.3)
1/2	1/4	-RU-FT8-FT4	1.85(47.0)	0.90(22.8)	0.87(22.2)	0.81(20.6)	0.19(4.8)	0.60(15.2)	0.56(14.3)
1/2	3/8	-RU-FT8-FT6	1.91(48.5)	0.90(22.8)	0.87(22.2)	0.81(20.6)	0.28(7.1)	0.66(16.8)	0.69(17.5)
5/8	3/8	-RU-FT10-FT6	1.94(49.3)	0.96(24.4)	1.00(25.4)	0.94(23.9)	0.28(7.1)	0.66(16.8)	0.69(17.5)
5/8	1/2	-RU-FT10-FT8	2.05(52.1)	0.96(24.4)	1.00(25.4)	0.94(23.9)	0.41(10.4)	0.90(22.8)	0.87(22.2)
3/4	1/4	-RU-FT12-FT4	1.94(49.3)	0.96(24.4)	1.13(28.6)	1.06(27.0)	0.19(4.8)	0.60(15.2)	0.56(14.3)
3/4	3/8	-RU-FT12-FT6	2.00(50.8)	0.96(24.4)	1.13(28.6)	1.06(27.0)	0.28(7.1)	0.66(16.8)	0.69(17.5)
3/4	1/2	-RU-FT12-FT8	2.11(53.6)	0.96(24.4)	1.13(28.6)	1.06(27.0)	0.41(10.4)	0.90(22.8)	0.87(22.2)
1	1/2	-RU-FT16-FT8	2.38(60.5)	1.23(31.2)	1.50(38.1)	1.37(34.9)	0.41(10.4)	0.90(22.8)	0.87(22.2)
1	3/4	-RU-FT16-FT12	2.38(60.5)	1.23(31.2)	1.50(38.1)	1.37(34.9)	0.62(15.7)	0.96(24.4)	1.13(28.6)

Metric Tube									
T-Tube O.D. (mm)	Tx-Tube O.D. (mm)	Basic Ordering Number	Dimension, mm(in.)						
			L	C	D	F	E	Cx	Gx
3	2	-RU-MT3-MT2	35.3(1.39)	12.9(0.51)	12.0(0.47)	12.0(0.47)	1.7(0.07)	12.9(0.51)	12.0(0.47)
6	3	-RU-MT6-MT3	38.6(1.52)	15.3(0.60)	14.0(0.55)	14.0(0.55)	2.4(0.09)	12.9(0.51)	12.0(0.47)
6	4	-RU-MT6-MT4	39.4(1.55)	15.3(0.60)	14.0(0.55)	14.0(0.55)	2.4(0.09)	13.7(0.54)	12.0(0.47)
8	6	-RU-MT8-MT6	42.3(1.67)	16.3(0.64)	16.0(0.63)	15.0(0.59)	4.8(0.19)	15.3(0.60)	14.0(0.55)
10	6	-RU-MT10-MT6	44.5(1.75)	17.2(0.68)	19.0(0.75)	18.0(0.71)	4.8(0.19)	15.3(0.60)	14.0(0.55)
10	8	-RU-MT10-MT8	45.1(1.78)	17.2(0.68)	19.0(0.75)	18.0(0.71)	6.4(0.25)	16.3(0.64)	16.0(0.63)
12	8	-RU-MT12-MT8	47.8(1.88)	22.8(0.90)	22.0(0.87)	22.0(0.87)	6.4(0.25)	16.3(0.64)	16.0(0.63)
12	10	-RU-MT12-MT10	48.7(1.92)	22.8(0.90)	22.0(0.87)	22.0(0.87)	7.9(0.31)	17.2(0.68)	19.0(0.75)
16	10	-RU-MT16-MT10	49.5(1.95)	24.4(0.96)	25.0(0.98)	24.0(0.94)	7.9(0.31)	17.2(0.68)	19.0(0.75)
16	12	-RU-MT16-MT12	52.0(2.05)	24.4(0.96)	25.0(0.98)	24.0(0.94)	9.5(0.37)	22.8(0.90)	22.0(0.87)
18	12	-RU-MT18-MT12	53.5(2.11)	24.4(0.96)	30.0(1.18)	27.0(1.06)	9.5(0.37)	22.8(0.90)	22.0(0.87)
25	18	-RU-MT25-MT18	61.0(2.40)	31.3(1.23)	38.0(1.50)	35.0(1.38)	15.1(0.59)	24.4(0.96)	30.0(1.18)
25	20	-RU-MT25-MT20	62.3(2.45)	31.3(1.23)	38.0(1.50)	35.0(1.38)	15.9(0.63)	26.0(1.02)	32.0(1.26)
30	20	-RU-MT30-MT20	75.4(2.97)	39.6(1.56)	50.0(1.97)	46.0(1.81)	15.9(0.63)	26.0(1.02)	32.0(1.26)
30	25	-RU-MT30-MT25	80.1(3.15)	39.6(1.56)	50.0(1.97)	46.0(1.81)	21.8(0.86)	31.3(1.23)	38.0(1.50)
32	20	-RU-MT32-MT20	77.8(3.06)	42.0(1.65)	50.0(1.97)	46.0(1.81)	15.9(0.63)	26.0(1.02)	32.0(1.26)
32	25	-RU-MT32-MT25	82.3(3.24)	42.0(1.65)	50.0(1.97)	46.0(1.81)	21.8(0.86)	31.3(1.23)	38.0(1.50)
38	25	-RU-MT38-MT25	92.0(3.62)	49.4(1.94)	60.0(2.36)	55.0(2.17)	21.8(0.86)	31.3(1.23)	38.0(1.50)
38	30	-RU-MT38-MT30	104.6(4.12)	49.4(1.94)	60.0(2.36)	55.0(2.17)	26.2(1.03)	39.6(1.56)	50.0(1.97)

4 Tube Fittings

Male Connector

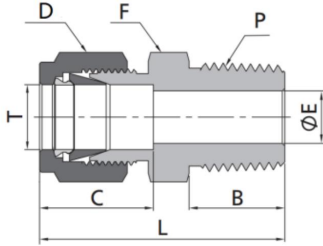

Fractional Tube to NPT Thread

T-Tube O.D. (in.)	P-NPT Size	Basic Ordering Number	Dimension, in. (mm)					
			L	B	C	E	D	F
1/16	1/16	-MC-FT1-MN1	0.94(23.9)	0.38(9.7)	0.34(8.6)	0.05(1.3)	0.31(7.9)	0.31(7.9)
1/16	1/8	-MC-FT1-MN2	1.03(26.2)	0.38(9.7)	0.34(8.6)	0.05(1.3)	0.31(7.9)	0.44(11.1)
1/8	1/16	-MC-FT2-MN1	1.17(29.7)	0.38(9.7)	0.50(12.7)	0.09(2.3)	0.44(11.1)	0.44(11.1)
1/8	1/8	-MC-FT2-MN2	1.20(30.5)	0.38(9.7)	0.50(12.7)	0.09(2.3)	0.44(11.1)	0.44(11.1)
1/8	1/4	-MC-FT2-MN4	1.40(35.6)	0.56(14.2)	0.50(12.7)	0.09(2.3)	0.44(11.1)	0.56(14.3)
3/16	1/8	-MC-FT3-MN2	1.23(31.2)	0.38(9.7)	0.54(13.7)	0.12(3.0)	0.50(12.7)	0.44(11.1)
3/16	1/4	-MC-FT3-MN4	1.43(36.3)	0.56(14.2)	0.54(13.7)	0.12(3.0)	0.50(12.7)	0.56(14.3)
1/4	1/16	-MC-FT4-MN1	1.29(32.8)	0.38(9.7)	0.60(15.2)	0.12(3.0)	0.56(14.3)	0.50(12.7)
1/4	1/8	-MC-FT4-MN2	1.29(32.8)	0.38(9.7)	0.60(15.2)	0.19(4.8)	0.56(14.3)	0.50(12.7)
1/4	1/4	-MC-FT4-MN4	1.49(37.8)	0.56(14.2)	0.60(15.2)	0.19(4.8)	0.56(14.3)	0.56(14.3)
1/4	3/8	-MC-FT4-MN6	1.51(38.4)	0.56(14.2)	0.60(15.2)	0.19(4.8)	0.56(14.3)	0.69(17.5)
5/16	1/8	-MC-FT5-MN2	1.34(34.0)	0.38(9.7)	0.64(16.3)	0.19(4.8)	0.63(15.9)	0.56(14.3)
5/16	1/4	-MC-FT5-MN4	1.52(38.6)	0.38(9.7)	0.64(16.3)	0.25(6.4)	0.63(15.9)	0.56(14.3)
5/16	3/8	-MC-FT5-MN6	1.54(39.1)	0.56(14.2)	0.64(16.3)	0.25(6.4)	0.63(15.9)	0.69(17.5)
5/16	1/2	-MC-FT5-MN8	1.79(45.5)	0.75(19.1)	0.64(16.3)	0.25(6.4)	0.63(15.9)	0.87(22.2)
3/8	1/8	-MC-FT6-MN2	1.39(35.3)	0.38(9.7)	0.66(16.8)	0.19(4.8)	0.69(17.5)	0.63(15.9)
3/8	1/4	-MC-FT6-MN4	1.57(39.9)	0.56(14.2)	0.66(16.8)	0.28(7.1)	0.69(17.5)	0.63(15.9)
3/8	3/8	-MC-FT6-MN6	1.57(39.9)	0.56(14.2)	0.66(16.8)	0.28(7.1)	0.69(17.5)	0.69(17.5)
3/8	1/2	-MC-FT6-MN8	1.82(46.2)	0.75(19.1)	0.66(16.8)	0.28(7.1)	0.69(17.5)	0.87(22.2)
1/2	1/8	-MC-FT8-MN2	1.53(38.9)	0.38(9.7)	0.90(22.9)	0.19(4.8)	0.87(22.2)	0.81(20.6)
1/2	1/4	-MC-FT8-MN4	1.71(43.4)	0.56(14.2)	0.90(22.9)	0.28(7.1)	0.87(22.2)	0.81(20.6)
1/2	3/8	-MC-FT8-MN6	1.71(43.4)	0.56(14.2)	0.90(22.9)	0.38(9.7)	0.87(22.2)	0.81(20.6)
1/2	1/2	-MC-FT8-MN8	1.93(49.0)	0.75(19.1)	0.90(22.9)	0.41(10.4)	0.87(22.2)	0.87(22.2)
1/2	3/4	-MC-FT8-MN12	1.99(50.5)	0.75(19.1)	0.90(22.9)	0.41(10.4)	0.87(22.2)	1.06(27.0)
1/2	1	-MC-FT8-MN16	2.25(57.2)	0.94(23.9)	0.90(22.9)	0.41(10.4)	0.87(22.2)	1.37(34.9)
5/8	1/4	-MC-FT10-MN4	1.74(44.2)	0.56(14.2)	0.96(24.4)	0.28(7.1)	1.00(25.4)	0.94(23.8)
5/8	3/8	-MC-FT10-MN6	1.74(44.2)	0.56(14.2)	0.96(24.4)	0.38(9.7)	1.00(25.4)	0.94(23.8)
5/8	1/2	-MC-FT10-MN8	1.93(49.0)	0.75(19.1)	0.96(24.4)	0.47(11.9)	1.00(25.4)	0.94(23.8)
5/8	3/4	-MC-FT10-MN12	1.99(50.5)	0.75(19.1)	0.96(24.4)	0.50(12.7)	1.00(25.4)	1.06(27.0)
3/4	3/8	-MC-FT12-MN6	1.99(50.5)	0.56(14.2)	0.96(24.4)	0.41(10.4)	1.13(28.6)	1.06(27.0)
3/4	1/2	-MC-FT12-MN8	2.25(57.2)	0.75(19.1)	0.96(24.4)	0.47(11.9)	1.13(28.6)	1.06(27.0)
3/4	3/4	-MC-FT12-MN12	1.99(50.5)	0.75(19.1)	0.96(24.4)	0.62(15.7)	1.13(28.6)	1.06(27.0)
3/4	1	-MC-FT12-MN16	2.25(57.2)	0.94(23.9)	0.96(24.4)	0.62(15.7)	1.13(28.6)	1.37(34.9)
7/8	1/2	-MC-FT14-MN8	2.26(57.4)	0.75(19.1)	1.02(25.9)	0.47(11.9)	1.25(31.8)	1.19(30.2)
7/8	3/4	-MC-FT14-MN12	2.45(62.2)	0.75(19.1)	1.02(25.9)	0.62(15.7)	1.25(31.8)	1.19(30.2)
7/8	1	-MC-FT14-MN16	2.45(62.2)	0.94(23.9)	1.02(25.9)	0.72(18.3)	1.25(31.8)	1.37(34.9)
1	1/2	-MC-FT16-MN8	3.04(77.2)	0.75(19.1)	1.23(31.2)	0.47(11.9)	1.50(38.1)	1.37(34.9)
1	3/4	-MC-FT16-MN12	3.04(77.2)	0.75(19.1)	1.23(31.2)	0.62(15.7)	1.50(38.1)	1.37(34.9)
1	1	-MC-FT16-MN16	3.50(88.9)	0.94(23.9)	1.23(31.2)	0.88(22.4)	1.50(38.1)	1.37(34.9)
1 1/8	1	-MC-FT18-MN16	2.45(62.2)	0.94(23.9)	1.23(31.2)	0.88(22.4)	1.81(46.0)	1.63(41.3)
1 1/4	1	-MC-FT20-MN16	3.04(77.2)	0.94(23.9)	1.62(41.1)	0.88(22.4)	1.87(47.6)	1.75(44.5)
1 1/4	1 1/4	-MC-FT20-MN20	3.04(77.2)	0.94(23.9)	1.62(41.1)	1.09(27.7)	1.87(47.6)	1.75(44.5)
1 1/2	1 1/2	-MC-FT24-MN24	3.50(88.9)	1.03(26.2)	1.97(50.0)	1.34(34.0)	2.25(57.2)	2.13(54.0)

5 Tube Fittings

Male Connector

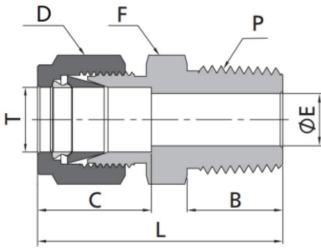

Fractional Tube to RT Thread

T-Tube O.D. (in.)	P-RT Size	Basic Ordering Number	Dimension, in. (mm)					
			L	B	C	E	D	F
1/8	1/8	-MC-FT2-RT2	1.20(30.5)	0.38(9.7)	0.50(12.7)	0.09(2.3)	0.44(11.1)	0.44(11.1)
1/8	1/4	-MC-FT2-RT4	1.40(35.6)	0.56(14.2)	0.50(12.7)	0.09(2.3)	0.44(11.1)	0.56(14.3)
1/4	1/8	-MC-FT4-RT2	1.29(32.8)	0.38(9.7)	0.60(15.2)	0.19(4.8)	0.56(14.3)	0.50(12.7)
1/4	1/4	-MC-FT4-RT4	1.49(37.8)	0.56(14.2)	0.60(15.2)	0.19(4.8)	0.56(14.3)	0.56(14.3)
1/4	3/8	-MC-FT4-RT6	1.51(38.4)	0.56(14.2)	0.60(15.2)	0.19(4.8)	0.56(14.3)	0.69(17.5)
1/4	1/2	-MC-FT4-RT8	1.76(44.7)	0.75(19.1)	0.60(15.2)	0.19(4.8)	0.56(14.3)	0.87(22.2)
5/16	1/8	-MC-FT5-RT2	1.34(34.0)	0.38(9.7)	0.64(16.3)	0.19(4.8)	0.63(15.9)	0.56(14.3)
5/16	1/4	-MC-FT5-RT4	1.52(38.6)	0.56(14.2)	0.64(16.3)	0.25(6.4)	0.63(15.9)	0.56(14.3)
3/8	1/8	-MC-FT6-RT2	1.39(35.3)	0.38(9.7)	0.66(16.8)	0.19(4.8)	0.69(17.5)	0.63(15.9)
3/8	1/4	-MC-FT6-RT4	1.57(39.9)	0.56(14.2)	0.66(16.8)	0.28(7.1)	0.69(17.5)	0.63(15.9)
3/8	3/8	-MC-FT6-RT6	1.57(39.9)	0.56(14.2)	0.66(16.8)	0.28(7.1)	0.69(17.5)	0.69(17.5)
3/8	1/2	-MC-FT6-RT8	1.82(46.2)	0.75(19.1)	0.66(16.8)	0.28(7.1)	0.69(17.5)	0.87(22.2)
3/8	3/4	-MC-FT6-RT12	1.88(47.8)	0.75(19.1)	0.66(16.8)	0.28(7.1)	0.69(17.5)	1.06(27.0)
1/2	1/4	-MC-FT3-RT4	1.71(43.4)	0.56(14.2)	0.90(22.9)	0.28(7.1)	0.87(22.2)	0.81(20.6)
1/2	3/8	-MC-FT3-RT6	1.71(43.4)	0.56(14.2)	0.90(22.9)	0.38(9.7)	0.87(22.2)	0.81(20.6)
1/2	1/2	-MC-FT3-RT8	1.93(49.0)	0.75(19.1)	0.90(22.9)	0.41(10.4)	0.87(22.2)	0.87(22.2)
1/2	3/4	-MC-FT3-RT12	1.99(50.5)	0.75(19.1)	0.90(22.9)	0.41(10.4)	0.87(22.2)	1.06(27.0)
5/8	1/2	-MC-FT10-RT8	1.93(49.0)	0.75(19.1)	0.96(24.4)	0.47(11.9)	1.00(25.4)	0.94(23.8)
3/4	3/4	-MC-FT12-RT12	1.99(50.5)	0.75(19.1)	0.96(24.4)	0.62(15.7)	1.13(28.6)	1.06(27.0)
3/4	1	-MC-FT12-RT16	2.25(57.2)	0.94(23.9)	0.96(24.4)	0.62(15.7)	1.13(28.6)	1.37(34.9)
1	3/4	-MC-FT16-RT12	2.26(57.4)	0.75(19.1)	1.23(31.2)	0.62(15.7)	1.50(38.1)	1.37(34.9)
1	1	-MC-FT16-RT16	2.45(62.2)	0.94(23.9)	1.23(31.2)	0.88(22.4)	1.50(38.1)	1.37(34.9)
1 1/8	1	-MC-FT18-RT16	2.45(62.2)	0.94(23.9)	1.23(31.2)	0.88(22.4)	1.81(46.0)	1.63(41.3)
1 1/4	1	-MC-FT20-RT16	3.04(77.2)	0.94(23.9)	1.62(41.1)	0.88(22.4)	1.87(47.6)	1.75(44.5)
1 1/4	1 1/4	-MC-FT20-RT20	3.04(77.2)	0.94(23.9)	1.62(41.1)	1.09(27.7)	1.87(47.6)	1.75(44.5)
1 1/2	1 1/2	-MC-FT24-RT24	3.50(88.9)	1.03(26.2)	1.97(50.0)	1.34(34.0)	2.25(57.2)	2.13(54.0)

Male Connector

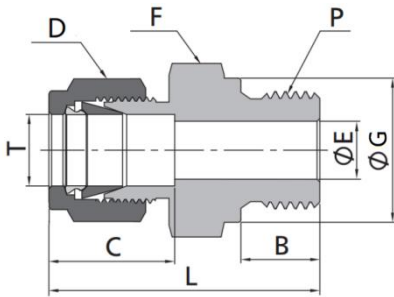

Fractional Tube to ISO Parallel Thread									
T-Tube O.D. (in.)	P-RS Size	Basic Ordering Number	Dimension, in. (mm)						
			L	B	C	E	D	F	G
1/8	1/8	-MC-FT2-RS2	1.18(30.0)	0.28(7.1)	0.50(12.7)	0.09(2.3)	0.44(11.1)	0.56(14.3)	0.54(13.7)
1/8	1/4	-MC-FT2-RS4	1.39(35.3)	0.44(11.2)	0.50(12.7)	0.09(2.3)	0.44(11.1)	0.75(19.1)	0.71(18.0)
1/8	3/8	-MC-FT2-RS6	1.43(36.3)	0.44(11.2)	0.50(12.7)	0.09(2.3)	0.44(11.1)	0.87(22.2)	0.86(21.8)
1/4	1/8	-MC-FT4-RS2	1.27(32.3)	0.28(7.1)	0.60(15.2)	0.16(4.0)	0.56(14.3)	0.56(14.3)	0.54(13.7)
1/4	1/4	-MC-FT4-RS4	1.48(37.6)	0.44(11.2)	0.60(15.2)	0.19(4.8)	0.56(14.3)	0.75(19.1)	0.71(18.0)
1/4	3/8	-MC-FT4-RS6	1.53(38.9)	0.44(11.2)	0.60(15.2)	0.19(4.8)	0.56(14.3)	0.87(22.2)	0.86(21.8)
1/4	1/2	-MC-FT4-RS8	1.76(44.7)	0.56(14.2)	0.60(15.2)	0.19(4.8)	0.56(14.3)	1.06(27.0)	1.02(25.9)
3/8	1/8	-MC-FT6-RS2	1.49(37.8)	0.28(7.1)	0.66(16.8)	0.16(4.0)	0.69(17.5)	0.63(15.9)	0.54(13.7)
3/8	1/4	-MC-FT6-RS4	1.54(39.1)	0.44(11.2)	0.66(16.8)	0.23(5.9)	0.69(17.5)	0.75(19.1)	0.71(18.0)
3/8	3/8	-MC-FT6-RS6	1.59(40.4)	0.44(11.2)	0.66(16.8)	0.28(7.1)	0.69(17.5)	0.87(22.2)	0.86(21.8)
3/8	1/2	-MC-FT6-RS8	1.82(46.2)	0.56(14.2)	0.66(16.8)	0.28(7.1)	0.69(17.5)	1.06(27.0)	1.02(25.9)
1/2	1/4	-MC-FT8-RS4	1.68(42.7)	0.44(11.2)	0.90(22.9)	0.23(5.9)	0.87(22.2)	0.81(20.6)	0.71(18.0)
1/2	3/8	-MC-FT8-RS6	1.70(43.2)	0.44(11.2)	0.90(22.9)	0.31(7.9)	0.87(22.2)	0.87(22.2)	0.86(21.8)
1/2	1/2	-MC-FT8-RS8	1.93(49.0)	0.56(14.2)	0.90(22.9)	0.41(10.4)	0.87(22.2)	1.06(27.0)	1.02(25.9)
3/4	1/2	-MC-FT12-RS8	1.93(49.0)	0.56(14.2)	0.96(24.4)	0.47(11.9)	1.13(28.6)	1.06(27.0)	1.02(25.9)
3/4	3/4	-MC-FT12-RS12	2.08(52.9)	0.62(15.7)	0.96(24.4)	0.62(15.7)	1.13(28.6)	1.31(33.3)	1.26(32.0)
1	1/2	-MC-FT16-RS8	2.19(55.5)	0.56(14.2)	1.23(31.2)	0.47(11.9)	1.50(38.1)	1.37(34.9)	1.02(25.9)
1	3/4	-MC-FT16-RS12	2.27(57.7)	0.62(15.7)	1.23(31.2)	0.63(16.0)	1.50(38.1)	1.37(34.9)	1.26(32.0)
1	1	-MC-FT16-RS16	2.36(59.9)	0.72(18.3)	1.23(31.2)	0.78(19.8)	1.50(38.1)	1.63(41.3)	1.54(39.1)

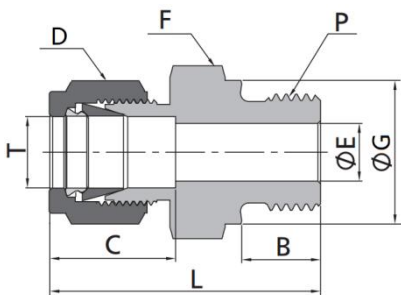

Fractional Tube to ISO Parallel Thread									
T-Tube O.D. (in.)	P-RP Size	Basic Ordering Number	Dimension, in. (mm)						
			L	B	C	E	D	F	G
1/8	1/8	-MC-FT2-RP2	1.18(30.0)	0.28(7.1)	0.50(12.7)	0.09(2.3)	0.44(11.1)	0.56(14.3)	0.54(13.8)
1/8	1/4	-MC-FT2-RP4	1.39(35.3)	0.44(11.2)	0.50(12.7)	0.09(2.3)	0.44(11.1)	0.75(19.1)	0.70(17.8)
1/4	1/8	-MC-FT4-RP2	1.27(32.3)	0.28(7.1)	0.60(15.2)	0.16(4.1)	0.56(14.3)	0.56(14.3)	0.54(13.8)
1/4	1/4	-MC-FT4-RP4	1.48(37.6)	0.44(11.2)	0.60(15.2)	0.19(4.8)	0.56(14.3)	0.75(19.1)	0.70(17.8)
1/2	3/8	-MC-FT8-RP6	1.59(40.4)	0.44(11.2)	0.90(22.9)	0.31(7.9)	0.87(22.2)	0.87(22.2)	0.86(21.8)
1/2	1/2	-MC-FT8-RP8	1.93(49.0)	0.56(14.2)	0.90(22.9)	0.41(10.4)	0.87(22.2)	1.06(27.0)	1.02(25.9)
3/4	1/2	-MC-FT12-RP8	1.93(49.0)	0.56(14.2)	0.96(24.4)	0.47(11.9)	1.13(28.6)	1.06(27.0)	1.02(25.9)
3/4	3/4	-MC-FT12-RP12	2.08(52.9)	0.62(15.7)	0.96(24.4)	0.62(15.7)	1.13(28.6)	1.31(33.3)	1.26(32.0)
1	1	-MC-FT16-RP16	2.36(59.9)	0.72(18.3)	1.23(31.2)	0.78(19.8)	1.50(38.1)	1.63(41.3)	1.53(38.8)

Male Connector

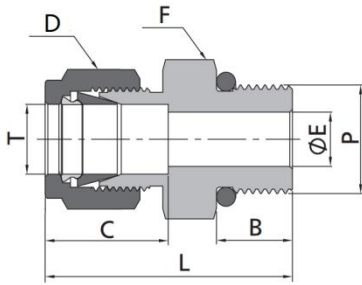

Fractional Tube to SAE/MS Thread								
T-Tube O.D. (in.)	P-SAE/MS Size	Basic Ordering Number	Dimension, in. (mm)					
			L	B	C	E	D	F
1/16	5/16-24	-MC-FT1-ST5	0.92(23.4)	030(7.6)	0.34(8.6)	0.05(1.3)	0.31 (7.9)	0.44(11.1)
1/8	5/16-24	-MC-FT2-ST5	1.18(30.0)	030(7.6)	0.50(12.7)	0.09(2.3)	0.44(11.1)	0.44(11.1)
1/8	7/16-20	-MC-FT2-ST7	1.24(31.5)	036(9.1)	0.50(12.7)	0.09(2.3)	0.44(11.1)	0.56(14.3)
1/8	9/16-18	-MC-FT2-ST9	1.31(33.3)	039(9.9)	0.50(12.7)	0.09(2.3)	0.44(11.1)	0.69(17.5)
3/16	3/8-24	-MC-FT3-ST6	1.20(30.5)	030(7.6)	0.54(13.7)	0.12(3.0)	0.50(12.7)	0.50(12.7)
1/4	5/16-24	-MC-FT4-ST5	1.27(32.3)	030(7.6)	0.60(15.2)	0.09(2.3)	0.56(14.3)	0.50(12.7)
1/4	7/16-20	-MC-FT4-ST7	1.34(34.0)	036(9.1)	0.60(15.2)	0.19(4.8)	0.56(14.3)	0.56(14.3)
1/4	9/16-18	-MC-FT4-ST9	1.40(35.6)	039(9.9)	0.60(15.2)	0.19(4.8)	0.56(14.3)	0.69(17.5)
1/4	3/4-16	-MC-FT4-ST12	1.48(37.6)	044(11.2)	0.60(15.2)	0.19(4.8)	0.56(14.3)	0.87(22.2)
1/4	7/8-14	-MC-FT4-ST14	1.60(40.6)	050(12.7)	0.60(15.2)	0.19(4.8)	0.56(14.3)	1.00(25.4)
5/16	1/2-20	-MC-FT5-ST8	1.37(34.8)	036(9.1)	0.64(16.3)	0.25(6.4)	0.63(15.9)	0.63(15.9)
3/8	7/16-20	-MC-FT6-ST7	1.40(35.6)	036(9.1)	0.66(16.8)	0.20(5.1)	0.69(17.5)	0.63(15.9)
3/8	9/16-18	-MC-FT6-ST9	1.46(37.1)	039(9.9)	0.66(16.8)	0.28(7.1)	0.69(17.5)	0.69(17.5)
3/8	3/4-16	-MC-FT6-ST12	1.54(39.1)	044(11.2)	0.66(16.8)	0.28(7.1)	0.69(17.5)	0.87(22.2)
3/8	7/8-14	-MC-FT6-ST14	1.66(42.2)	050(12.7)	0.66(16.8)	0.28(7.1)	0.69(17.5)	1.00(25.4)
1/2	9/16-18	-MC-FT8-ST9	1.54(39.1)	039(9.9)	0.90(22.9)	0.28(7.1)	0.87(22.2)	0.81 (20.6)
1/2	3/4-16	-MC-FT8-ST12	1.65(41.9)	044(11.2)	0.90(22.9)	0.41(10.4)	0.87(22.2)	0.87(22.2)
1/2	7/8-14	-MC-FT8-ST14	1.77(45.0)	050(12.7)	0.90(22.9)	0.41(10.4)	0.87(22.2)	1.00(25.4)
1/2	1 1/16-12	-MC-FT8-ST17	1.93(49.0)	059(15.0)	0.90(22.9)	0.41(10.4)	0.87(22.2)	1.25(31.8)
5/8	3/4-16	-MC-FT10-ST12	1.65(41.9)	044(11.2)	0.96(24.4)	0.42(10.7)	1.00(25.4)	0.94(23.8)
5/8	7/8-14	-MC-FT10-ST14	1.78(45.2)	050(12.7)	0.96(24.4)	0.50(12.7)	1.00(25.4)	1.00(25.4)
3/4	3/4-16	-MC-FT12-ST12	1.81(46.0)	044(11.2)	0.96(24.4)	0.42(10.7)	1.13(28.6)	1.06(27.0)
3/4	1 1/16-12	-MC-FT12-ST17	1.93(49.0)	059(15.0)	0.96(24.4)	0.62(15.7)	1.13(28.6)	1.25(31.8)
3/4	1 5/16-12	-MC-FT12-ST21	1.96(49.8)	059(15.0)	0.96(24.4)	0.63(16.0)	1.13(28.6)	1.50(38.1)
7/8	1 3/16-12	-MC-FT14-ST19	1.93(49.0)	059(15.0)	1.02(25.9)	0.72(18.3)	1.25(31.8)	1.37(34.9)
1	1 1/16-12	-MC-FT16-ST17	2.10(53.3)	059(15.0)	1.23(31.2)	0.54(13.8)	1.50(38.1)	1.37(34.9)
1	1 5/16-12	-MC-FT16-ST21	2.14(54.4)	059(15.0)	1.23(31.2)	0.88(22.4)	1.50(38.1)	1.50(38.1)
1 1/4	1 5/8-12	-MC-FT20-ST26	2.69(68.3)	059(15.0)	1.62 (41.1)	1.09(27.7)	1.87(47.6)	1.87(47.6)
1 1/2	1 7/8-12	-MC-FT24-ST30	3.06(77.7)	059(15.0)	1.97(50.0)	1.34(34.0)	2.25(57.2)	2.13(54.0)

Male Connector

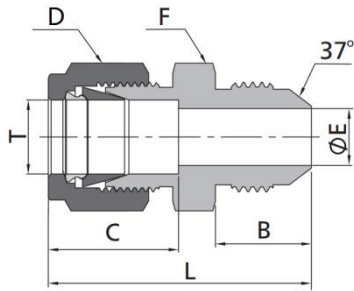

Fractional Tube to 37° Flared								
T-Tube O.D. (in.)	Flared Size	Basic Ordering Number	Dimension, in. (mm)					
			L	B	C	E	D	F
1/16	1/8	-MC-FT1-AN2	1.07(27.2)	0.45(11.4)	0.34(8.6)	0.05(1.3)	0.31(7.9)	0.44(11.1)
1/8	1/8	-MC-FT2-AN2	1.27(32.3)	0.45(11.4)	0.50(12.7)	0.06(1.5)	0.44(11.1)	0.44(11.1)
1/8	1/4	-MC-FT2-AN4	1.38(35.1)	0.55(14.0)	0.50(12.7)	0.09(2.3)	0.44(11.1)	0.50(12.7)
3/16	3/16	-MC-FT3-AN3	1.32(33.5)	0.48(12.2)	0.54(13.7)	0.09(2.3)	0.50(12.7)	0.44(11.1)
1/4	1/4	-MC-FT4-AN4	1.48(37.6)	0.55(14.0)	0.60(15.2)	0.17(4.3)	0.56(14.3)	0.50(12.7)
5/16	5/16	-MC-FT5-AN5	1.51(38.4)	0.55(14.0)	0.64(16.2)	0.23(5.8)	0.63(15.9)	0.56(14.3)
3/8	1/4	-MC-FT6-AN4	1.56(39.6)	0.55(14.0)	0.66(16.8)	0.17(4.3)	0.69(17.5)	0.63(15.9)
3/8	3/8	-MC-FT6-AN6	1.56(39.6)	0.56(14.1)	0.66(16.8)	0.28(7.1)	0.69(17.5)	0.63(15.9)
1/2	1/2	-MC-FT8-AN8	1.81(46.0)	0.66(16.7)	0.90(22.8)	0.39(9.9)	0.87(22.2)	0.81(20.6)
5/8	5/8	-MC-FT10-AN10	1.93(49.0)	0.76(19.3)	0.96(24.5)	0.48(12.3)	1.00(25.4)	0.94(23.8)
3/4	3/4	-MC-FT12-AN12	2.10(53.3)	0.86(21.9)	0.96(24.4)	0.61(15.5)	1.13(28.6)	1.13(28.6)
1	1	-MC-FT16-AN16	2.42(61.5)	0.91(23.1)	1.23(31.2)	0.84(21.3)	1.50(38.1)	1.37(34.9)

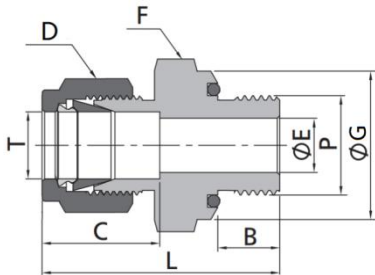

Fractional Tube to SAE/MS Thread									
T-Tube O.D. (in.)	P-SAE/MS Size	Basic Ordering Number	Dimension, in. (mm)						
			L	B	C	E	D	F	G
1/16	5/16-24	-MC-FT1-OS5	1.05(26.7)	0.34(8.6)	0.34(8.6)	0.05(1.3)	0.31(7.9)	0.56(14.3)	0.55(14.0)
1/8	5/16-24	-MC-FT2-OS5	1.29(32.8)	0.34(8.6)	0.50(12.7)	0.09(2.3)	0.44(11.1)	0.56(14.3)	0.55(14.0)
3/16	3/8-24	-MC-FT3-OS6	1.35(34.3)	0.38(9.7)	0.54(13.7)	0.12(3.0)	0.50(12.7)	0.63(15.9)	0.62(15.7)
1/4	7/16-20	-MC-FT4-OS7	1.51(38.4)	0.41(10.4)	0.60(15.2)	0.19(4.8)	0.56(14.3)	0.75(19.1)	0.74(18.8)
5/16	1/2-20	-MC-FT5-OS8	1.60(40.6)	0.44(11.2)	0.64(16.3)	0.25(6.4)	0.63(15.9)	0.87(22.2)	0.86(21.8)
3/8	9/16-18	-MC-FT6-OS9	1.67(42.4)	0.47(11.9)	0.66(16.8)	0.28(7.1)	0.69(17.5)	0.94(23.8)	0.93(23.6)
1/2	3/4-16	-MC-FT8-OS12	1.81(46.0)	0.47(11.9)	0.90(22.9)	0.41(10.4)	0.87(22.2)	1.13(28.6)	1.12(28.4)
3/4	1 1/16-12	-MC-FT12-OS17	2.06(52.3)	0.56(14.2)	0.96(24.4)	0.62(15.7)	1.13(28.6)	1.50(38.1)	1.49(37.8)
1	1 5/16-12	-MC-FT16-OS21	2.29(58.2)	0.56(14.2)	1.23(31.2)	0.88(22.4)	1.50(38.1)	1.75(44.5)	1.74(44.2)

Male Connector

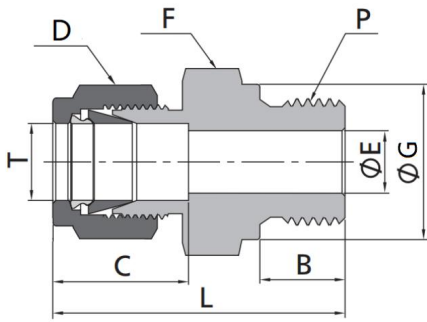

Fractional Tube to Metric Thread

T-Tube O.D. (in.)	P-Metric Size	Basic Ordering Number	Dimension, in. (mm)						
			L	B	C	E	D	F	G
1/8	M14x 1.5	-MC-FT2-MS14	1.44(36.7)	0.47(12.0)	0.50(12.7)	0.09(2.3)	0.44(11.1)	0.75(19.1)	0.75(19.0)
1/8	M16x 1.5	-MC-FT2-MS16	1.48(37.5)	0.47(12.0)	0.50(12.7)	0.09(2.3)	0.44(11.1)	0.87(22.2)	0.83(21.0)
1/8	M18x 1.5	-MC-FT2-MS18	1.52(38.5)	0.47(12.0)	0.50(12.7)	0.09(2.3)	0.44(11.1)	0.94(23.8)	0.91(23.0)
1/8	M20x 1.5	-MC-FT2-MS20	1.62(41.1)	0.55(14.0)	0.50(12.7)	0.09(2.3)	0.44(11.1)	1.00(25.4)	0.98(25.0)
1/4	M14x 1.5	-MC-FT4-MS14	1.50(38.0)	0.47(12.0)	0.60(15.2)	0.19(4.8)	0.56(14.3)	0.75(19.1)	0.75(19.0)
1/4	M16x 1.5	-MC-FT4-MS16	1.57(39.9)	0.47(12.0)	0.60(15.2)	0.19(4.8)	0.56(14.3)	0.87(22.2)	0.83(21.0)
1/4	M18x 1.5	-MC-FT4-MS18	1.61(40.8)	0.47(12.0)	0.60(15.2)	0.19(4.8)	0.56(14.3)	0.94(23.8)	0.91(23.0)
1/4	M20x 1.5	-MC-FT4-MS20	1.72(43.6)	0.55(14.0)	0.60(15.2)	0.19(4.8)	0.56(14.3)	1.00(25.4)	0.98(25.0)
3/8	M14x 1.5	-MC-FT6-MS14	1.63(41.3)	0.47(12.0)	0.66(16.8)	0.28(7.1)	0.69(17.5)	0.75(19.1)	0.75(19.0)
3/8	M16x 1.5	-MC-FT6-MS16	1.63(41.3)	0.47(12.0)	0.66(16.8)	0.28(7.1)	0.69(17.5)	0.87(22.2)	0.83(21.0)
3/8	M18x 1.5	-MC-FT6-MS18	1.65(41.8)	0.47(12.0)	0.66(16.8)	0.28(7.1)	0.69(17.5)	0.94(23.8)	0.91(23.0)
3/8	M20x 1.5	-MC-FT6-MS20	1.78(45.1)	0.55(14.0)	0.66(16.8)	0.28(7.1)	0.69(17.5)	1.00(25.4)	0.98(25.0)
1/2	M16x 1.5	-MC-FT8-MS16	1.73(44.0)	0.47(12.0)	0.90(22.8)	0.35(9.0)	0.87(22.2)	0.87(22.2)	0.83(21.0)
1/2	M18x 1.5	-MC-FT8-MS18	1.73(44.0)	0.47(12.0)	0.90(22.9)	0.39(10.0)	0.87(22.2)	0.94(23.8)	0.91(23.0)
1/2	M20x 1.5	-MC-FT8-MS20	1.89(47.9)	0.55(14.0)	0.90(22.9)	0.41(10.4)	0.87(22.2)	1.00(25.4)	0.98(25.0)
1/2	M22x 1.5	-MC-FT8-MS22	1.91(48.5)	0.55(14.0)	0.90(22.9)	0.41(10.4)	0.87(22.2)	1.06(27.0)	1.06(27.0)

Male Connector

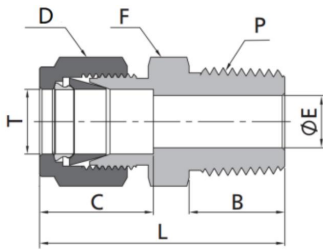

Metric Tube to NPT Thread

T-Tube O.D. (mm)	P-NPT Size	Basic Ordering Number	Dimension, mm. (in.)					
			L	B	C	E	D	F
2	1/8	-MC-MT2-MN2	30.5(1.20)	9.7(0.38)	12.9(0.51)	1.7(0.07)	12.0(0.47)	12.0(0.47)
3	1/8	-MC-MT3-MN2	30.5(1.20)	9.7(0.38)	12.9(0.51)	2.4(0.09)	12.0(0.47)	12.0(0.47)
3	1/4	-MC-MT3-MN4	35.6(1.40)	14.2(0.56)	12.9(0.51)	2.4(0.09)	12.0(0.47)	14.0(0.55)
4	1/8	-MC-MT4-MN2	31.2(1.23)	9.7(0.38)	13.7(0.54)	2.4(0.09)	12.0(0.47)	12.0(0.47)
4	1/4	-MC-MT4-MN4	36.3(1.43)	14.2(0.56)	13.7(0.54)	2.4(0.09)	12.0(0.47)	14.0(0.55)
6	1/8	-MC-MT6-MN2	32.8(1.29)	9.7(0.38)	15.3(0.60)	4.8(0.19)	14.0(0.55)	14.0(0.55)
6	1/4	-MC-MT6-MN4	37.9(1.49)	14.2(0.56)	15.3(0.60)	4.8(0.19)	14.0(0.55)	14.0(0.55)
6	3/8	-MC-MT6-MN6	38.4(1.51)	14.2(0.56)	15.3(0.60)	4.8(0.19)	14.0(0.55)	18.0(0.71)
8	1/8	-MC-MT8-MN2	34.2(1.35)	9.7(0.38)	16.2(0.64)	4.8(0.19)	16.0(0.63)	15.0(0.59)
8	1/4	-MC-MT8-MN4	38.7(1.52)	14.2(0.56)	16.2(0.64)	6.4(0.25)	16.0(0.63)	15.0(0.59)
8	3/8	-MC-MT8-MN6	39.3(1.55)	14.2(0.56)	16.2(0.64)	6.4(0.25)	16.0(0.63)	18.0(0.71)
10	1/4	-MC-MT10-MN4	40.9(1.61)	14.2(0.56)	17.2(0.68)	7.1(0.28)	19.0(0.75)	18.0(0.71)
10	3/8	-MC-MT10-MN6	40.9(1.61)	14.2(0.56)	17.2(0.68)	7.9(0.31)	19.0(0.75)	18.0(0.71)
10	1/2	-MC-MT10-MN8	46.5(1.83)	19.1(0.75)	17.2(0.68)	7.9(0.31)	19.0(0.75)	22.0(0.87)
12	1/4	-MC-MT12-MN4	43.4(1.71)	14.2(0.56)	22.8(0.90)	7.1(0.28)	22.0(0.87)	22.0(0.87)
12	3/8	-MC-MT12-MN6	43.4(1.71)	14.2(0.56)	22.8(0.90)	9.5(0.37)	22.0(0.87)	22.0(0.87)
12	1/2	-MC-MT12-MN8	49.0(1.93)	19.1(0.75)	22.8(0.90)	9.5(0.37)	22.0(0.87)	22.0(0.87)
12	3/4	-MC-MT12-MN12	50.5(1.99)	19.1(0.75)	22.8(0.90)	9.5(0.37)	22.0(0.87)	27.0(1.06)
14	1/8	-MC-MT14-MN2	38.8(1.53)	9.7(0.38)	24.4(0.96)	4.8(0.19)	25.0(0.98)	24.0(0.94)
14	1/4	-MC-MT14-MN4	44.1(1.74)	14.2(0.56)	24.4(0.96)	7.1(0.28)	25.0(0.98)	24.0(0.94)
14	3/8	-MC-MT14-MN6	44.1(1.74)	14.2(0.56)	24.4(0.96)	9.5(0.37)	25.0(0.98)	24.0(0.94)
14	1/2	-MC-MT14-MN8	49.0(1.93)	19.1(0.75)	24.4(0.96)	11.1(0.44)	25.0(0.98)	24.0(0.94)
14	3/4	-MC-MT14-MN12	50.5(1.99)	19.1(0.75)	24.4(0.96)	11.1(0.44)	25.0(0.98)	27.0(1.06)
15	1/2	-MC-MT15-MN8	49.0(1.93)	19.1(0.75)	24.4(0.96)	11.9(0.47)	25.0(0.98)	24.0(0.94)
15	3/4	-MC-MT15-MN12	50.5(1.99)	19.1(0.75)	24.4(0.96)	11.9(0.47)	25.0(0.98)	27.0(1.06)
16	1/4	-MC-MT16-MN4	44.1(1.74)	14.2(0.56)	24.4(0.96)	7.1(0.28)	25.0(0.98)	24.0(0.94)
16	3/8	-MC-MT16-MN6	44.1(1.74)	14.2(0.56)	24.4(0.96)	9.5(0.37)	25.0(0.98)	24.0(0.94)
16	1/2	-MC-MT16-MN8	49.0(1.93)	19.1(0.75)	24.4(0.96)	11.9(0.47)	25.0(0.98)	24.0(0.94)
16	3/4	-MC-MT16-MN12	50.5(1.99)	19.1(0.75)	24.4(0.96)	12.7(0.5)	25.0(0.98)	27.0(1.06)
18	3/8	-MC-MT18-MN6	45.6(1.80)	14.2(0.56)	24.4(0.96)	9.5(0.37)	30.0(1.18)	27.0(1.06)
18	1/2	-MC-MT18-MN8	50.5(1.99)	19.1(0.75)	24.4(0.96)	11.9(0.47)	30.0(1.18)	27.0(1.06)
18	3/4	-MC-MT18-MN12	50.5(1.99)	19.1(0.75)	24.4(0.96)	15.1(0.59)	30.0(1.18)	27.0(1.06)
20	1/2	-MC-MT20-MN8	52.3(2.06)	19.1(0.75)	26.0(1.02)	11.9(0.47)	32.0(1.26)	30.0(1.18)
20	3/4	-MC-MT20-MN12	52.3(2.06)	19.1(0.75)	26.0(1.02)	15.9(0.63)	32.0(1.26)	30.0(1.18)
20	1	-MC-MT20-MN16	57.1(2.25)	23.9(0.94)	26.0(1.02)	15.9(0.63)	32.0(1.26)	35.0(1.38)
22	1/2	-MC-MT22-MN8	52.3(2.06)	19.1(0.75)	26.0(1.02)	11.9(0.47)	32.0(1.26)	30.0(1.18)
22	3/4	-MC-MT22-MN12	52.3(2.06)	19.1(0.75)	26.0(1.02)	15.9(0.63)	32.0(1.26)	30.0(1.18)
22	1	-MC-MT22-MN16	57.1(2.25)	23.9(0.94)	26.0(1.02)	18.3(0.72)	32.0(1.26)	35.0(1.38)
25	1/2	-MC-MT25-MN8	57.5(2.26)	19.1(0.75)	31.3(1.23)	11.9(0.47)	38.0(1.50)	35.0(1.38)
25	3/4	-MC-MT25-MN12	57.5(2.26)	19.1(0.75)	31.3(1.23)	15.9(0.63)	38.0(1.50)	35.0(1.38)
25	1	-MC-MT25-MN16	62.3(2.45)	23.9(0.94)	31.3(1.23)	21.8(0.86)	38.0(1.50)	35.0(1.38)
28	1	-MC-MT28-MN16	72.4(2.85)	23.9(0.94)	36.6(1.44)	21.8(0.86)	46.0(1.81)	41.0(1.61)
28	1 1/4	-MC-MT28-MN20	73.1(2.88)	23.9(0.94)	36.6(1.44)	21.8(0.86)	46.0(1.81)	46.0(1.81)
30	1 1/4	-MC-MT30-MN20	77.2(3.04)	23.9(0.94)	39.6(1.56)	26.2(1.03)	50.0(1.97)	46.0(1.81)
32	1 1/4	-MC-MT32-MN20	79.6(3.13)	23.9(0.94)	42.0(1.65)	28.6(1.13)	50.0(1.97)	46.0(1.81)
38	1 1/2	-MC-MT38-MN24	91.6(3.61)	26.2(1.03)	49.4(1.94)	33.7(1.33)	60.0(2.36)	55.0(2.17)

Male Connector

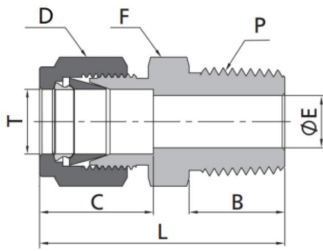

Metric Tube to RT Thread

T-Tube O.D. (mm)	P-RT Size	Basic Ordering Number	Dimension, mm. (in.)					
			L	B	C	E	D	F
2	1/8	-MC-MT2-RT2	30.5(1.20)	9.7(0.38)	12.9(0.51)	1.7(0.07)	12.0(0.47)	12.0(0.47)
3	1/8	-MC-MT3-RT2	30.5(1.20)	9.7(0.38)	12.9(0.51)	2.4(0.09)	12.0(0.47)	12.0(0.47)
3	1/4	-MC-MT3-RT4	35.6(1.40)	14.2(0.56)	12.9(0.51)	2.4(0.09)	12.0(0.47)	14.0(0.55)
4	1/8	-MC-MT4-RT2	31.2(1.23)	9.7(0.38)	13.7(0.54)	2.4(0.09)	12.0(0.47)	12.0(0.47)
4	1/4	-MC-MT4-RT4	36.3(1.43)	14.2(0.56)	13.7(0.54)	2.4(0.09)	12.0(0.47)	14.0(0.55)
6	1/8	-MC-MT6-R72	32.8(1.29)	9.7(0.38)	15.3(0.60)	4.8(0.19)	14.0(0.55)	14.0(0.55)
6	1/4	-MC-MT6-RT4	37.9(1.49)	14.2(0.56)	15.3(0.60)	4.8(0.19)	14.0(0.55)	14.0(0.55)
6	3/8	-MC-MT6-RT6	38.4(1.51)	14.2(0.56)	15.3(0.60)	4.8(0.19)	14.0(0.55)	18.0(0.71)
8	1/8	-MC-MT8-RT2	34.2(1.35)	9.7(0.38)	16.2(0.64)	4.8(0.19)	16.0(0.63)	15.0(0.59)
8	1/4	-MC-MT8-RT4	38.7(1.52)	14.2(0.56)	16.2(0.64)	6.4(0.25)	16.0(0.63)	15.0(0.59)
8	3/8	-MC-MT8-RT6	39.2(1.54)	14.2(0.56)	16.2(0.64)	6.4(0.25)	16.0(0.63)	18.0(0.71)
10	1/4	-MC-MT10-RT4	40.9(1.61)	14.2(0.56)	17.2(0.68)	7.1(0.28)	19.0(0.75)	18.0(0.71)
10	3/8	-MC-MT10-RT6	40.9(1.61)	14.2(0.56)	17.2(0.68)	7.9(0.31)	19.0(0.75)	18.0(0.71)
10	1/2	-MC-MT10-RT8	46.5(1.83)	19.1(0.75)	17.2(0.68)	7.9(0.31)	19.0(0.75)	22.0(0.87)
12	1/4	-MC-MT12-RT4	43.4(1.71)	14.2(0.56)	22.8(0.90)	7.1(0.28)	22.0(0.87)	22.0(0.87)
12	3/8	-MC-MT12-RT6	43.4(1.71)	14.2(0.56)	22.8(0.90)	9.5(0.37)	22.0(0.87)	22.0(0.87)
12	1/2	-MC-MT12-RT8	49.0(1.93)	19.1(0.75)	22.8(0.90)	9.5(0.37)	22.0(0.87)	22.0(0.87)
12	3/4	-MC-MT12-RT12	50.5(1.99)	19.1(0.75)	22.8(0.90)	9.5(0.37)	22.0(0.87)	27.0(1.06)
14	1/4	-MC-MT14-RT4	44.1(1.74)	14.2(0.56)	22.4(0.88)	7.1(0.28)	25.0(0.98)	24.0(0.94)
14	3/8	-MC-MT14-RT6	44.1(1.74)	14.2(0.56)	22.4(0.88)	7.9(0.31)	25.0(0.98)	24.0(0.94)
14	1/2	-MC-MT14-RT8	49.0(1.93)	19.1(0.75)	22.4(0.88)	11.1(0.44)	25.0(0.98)	24.0(0.94)
14	3/4	-MC-MT14-RT12	50.5(1.99)	19.1(0.75)	22.4(0.88)	11.1(0.44)	25.0(0.98)	27.0(1.06)
15	1/2	-MC-MT15-RT8	49.0(1.93)	19.1(0.75)	22.4(0.88)	11.9(0.47)	25.0(0.98)	24.0(0.94)
16	1/4	-MC-MT16-RT4	44.1(1.74)	14.2(0.56)	22.4(0.88)	7.1(0.28)	25.0(0.98)	24.0(0.94)
16	3/8	-MC-MT16-RT6	44.1(1.74)	14.2(0.56)	22.4(0.88)	9.5(0.37)	25.0(0.98)	24.0(0.94)
16	1/2	-MC-MT16-RT8	49.0(1.93)	19.1(0.75)	22.4(0.88)	11.9(0.47)	25.0(0.98)	24.0(0.94)
16	3/4	-MC-MT16-RT12	50.5(1.99)	19.1(0.75)	22.4(0.88)	12.7(0.5)	25.0(0.98)	27.0(1.06)
18	1/2	-MC-MT18-RT8	50.5(1.99)	19.1(0.75)	22.4(0.88)	11.9(0.47)	30.0(1.18)	27.0(1.06)
18	3/4	-MC-MT18-RT12	50.5(1.99)	19.1(0.75)	22.4(0.88)	15.1(0.59)	30.0(1.18)	27.0(1.06)
20	1/2	-MC-MT20-RT8	52.3(2.06)	19.1(0.75)	26.0(1.02)	11.9(0.47)	32.0(1.26)	30.0(1.18)
20	3/4	-MC-MT20-RT12	52.3(2.06)	19.1(0.75)	26.0(1.02)	15.9(0.63)	32.0(1.26)	30.0(1.18)
22	3/4	-MC-MT22-RT12	52.3(2.06)	19.1(0.75)	26.0(1.02)	15.9(0.63)	32.0(1.26)	30.0(1.18)
22	1	-MC-MT22-RT16	57.1(2.25)	23.9(0.94)	26.0(1.02)	18.3(0.72)	32.0(1.26)	35.0(1.38)
25	1/2	-MC-MT25-RT8	57.5(2.26)	19.1(0.75)	31.3(1.23)	11.9(0.47)	38.0(1.50)	35.0(1.38)
25	3/4	-MC-MT25-RT12	57.5(2.26)	19.1(0.75)	31.3(1.23)	15.9(0.63)	38.0(1.50)	35.0(1.38)
25	1	-MC-MT25-RT16	62.3(2.45)	23.9(0.94)	31.3(1.23)	21.8(0.86)	38.0(1.50)	35.0(1.38)
28	1	-MC-MT28-RT16	72.4(2.85)	23.9(0.94)	36.6(1.44)	21.8(0.86)	46.0(1.81)	41.0(1.61)
28	1 1/4	-MC-MT28-RT20	73.1(2.88)	23.9(0.94)	36.6(1.44)	21.8(0.86)	46.0(1.81)	46.0(1.81)
30	1 1/4	-MC-MT30-RT20	77.2(3.04)	23.9(0.94)	39.6(1.56)	26.2(1.03)	50.0(1.97)	46.0(1.81)
32	1 1/4	-MC-MT32-RT20	79.6(3.13)	23.9(0.94)	42.0(1.65)	28.6(1.13)	50.0(1.97)	46.0(1.81)
38	1 1/2	-MC-MT38-RT24	91.6(3.61)	26.2(1.03)	49.4(1.94)	33.7(1.33)	60.0(2.36)	55.0(2.17)

Male Connector

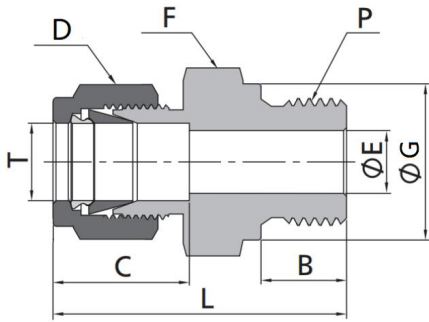

Metric Tube to ISO Parallel Thread									
T-Tube O.D. (mm)	P-RS Size	Basic Ordering Number	Dimension, mm. (in.)						
			L	B	C	E	D	F	G
2	1/8	-MC-MT2-RS2	30.0(1.18)	7.1(0.28)	12.9(0.51)	1.7(0.07)	12.0(0.47)	14.0(0.55)	13.7(0.54)
3	1/8	-MC-MT3-RS2	30.0(1.18)	7.1(0.28)	12.9(0.51)	2.4(0.09)	12.0(0.47)	14.0(0.55)	13.7(0.54)
3	1/4	-MC-MT3-RS4	35.3(1.39)	11.2(0.44)	12.9(0.51)	2.4(0.09)	12.0(0.47)	19.0(0.75)	18.0(0.71)
4	1/8	-MC-MT4-RS2	30.7(1.21)	7.1(0.28)	13.7(0.54)	2.4(0.09)	12.0(0.47)	14.0(0.55)	13.7(0.54)
4	1/4	-MC-MT4-RS4	36.0(1.42)	11.2(0.44)	13.7(0.54)	2.4(0.09)	12.0(0.47)	19.0(0.75)	18.0(0.71)
6	1/8	-MC-MT6-RS2	32.3(1.27)	7.1(0.28)	15.3(0.60)	4.0(0.16)	14.0(0.55)	14.0(0.55)	13.7(0.54)
6	1/4	-MC-MT6-RS4	37.6(1.48)	11.2(0.44)	15.3(0.60)	4.8(0.19)	14.0(0.55)	19.0(0.75)	18.0(0.71)
6	3/8	-MC-MT6-RS6	38.9(1.53)	11.2(0.44)	15.3(0.60)	4.8(0.19)	14.0(0.55)	22.0(0.87)	21.6(0.85)
8	1/8	-MC-MT8-RS2	33.2(1.31)	7.1(0.28)	16.2(0.64)	4.0(0.16)	16.0(0.63)	15.0(0.59)	14.5(0.57)
8	1/4	-MC-MT8-RS4	38.5(1.52)	11.2(0.44)	16.2(0.64)	6.4(0.25)	16.0(0.63)	19.0(0.75)	18.0(0.71)
8	3/8	-MC-MT8-RS6	39.8(1.57)	11.2(0.44)	16.2(0.64)	6.4(0.25)	16.0(0.63)	22.0(0.87)	21.6(0.85)
10	1/4	-MC-MT10-RS4	39.4(1.55)	11.2(0.44)	17.2(0.68)	5.9(0.23)	19.0(0.75)	19.0(0.75)	18.0(0.71)
10	3/8	-MC-MT10-RS6	40.6(1.60)	11.2(0.44)	17.2(0.68)	7.9(0.31)	19.0(0.75)	22.0(0.87)	21.6(0.85)
10	1/2	-MC-MT10-RS8	46.5(1.83)	14.2(0.56)	17.2(0.68)	7.9(0.31)	19.0(0.75)	27.0(1.06)	25.9(1.02)
12	1/4	-MC-MT12-RS4	42.6(1.68)	11.2(0.44)	22.8(0.90)	5.9(0.23)	22.0(0.87)	22.0(0.87)	21.6(0.85)
12	3/8	-MC-MT12-RS6	43.1(1.70)	11.2(0.44)	22.8(0.90)	7.9(0.31)	22.0(0.87)	22.0(0.87)	21.6(0.85)
12	1/2	-MC-MT12-RS8	49.0(1.93)	14.2(0.56)	22.8(0.90)	9.5(0.37)	22.0(0.87)	27.0(1.06)	25.9(1.02)
12	3/4	-MC-MT12-RS12	52.8(2.08)	15.7(0.62)	22.8(0.90)	9.5(0.37)	22.0(0.87)	35.0(1.38)	32.0(1.26)
14	3/8	-MC-MT14-RS6	43.9(1.73)	11.2(0.44)	24.4(0.96)	7.9(0.31)	25.0(0.98)	24.0(0.94)	21.6(0.85)
14	1/2	-MC-MT14-RS8	49.0(1.93)	14.2(0.56)	24.4(0.96)	11.1(0.44)	25.0(0.98)	27.0(1.06)	25.9(1.02)
14	3/4	-MC-MT14-RS12	52.8(2.08)	15.7(0.62)	24.4(0.96)	11.1(0.44)	25.0(0.98)	35.0(1.38)	32.0(1.26)
15	3/8	-MC-MT15-RS6	43.9(1.73)	11.2(0.44)	24.4(0.96)	7.9(0.31)	25.0(0.98)	24.0(0.94)	21.6(0.85)
15	1/2	-MC-MT15-RS8	49.0(1.93)	14.2(0.56)	24.4(0.96)	11.9(0.47)	25.0(0.98)	27.0(1.06)	25.9(1.02)
15	3/4	-MC-MT15-RS12	52.8(2.08)	15.7(0.62)	24.4(0.96)	11.9(0.47)	25.0(0.98)	35.0(1.38)	32.0(1.26)
16	3/8	-MC-MT16-RS6	43.9(1.73)	11.2(0.44)	24.4(0.96)	7.9(0.31)	25.0(0.98)	24.0(0.94)	21.6(0.85)
16	1/2	-MC-MT16-RS8	49.0(1.93)	14.2(0.56)	24.4(0.96)	11.9(0.47)	25.0(0.98)	27.0(1.06)	25.9(1.02)
18	1/2	-MC-MT18-RS8	49.0(1.93)	14.2(0.56)	24.4(0.96)	11.9(0.47)	30.0(1.18)	27.0(1.06)	25.9(1.02)
18	3/4	-MC-MT18-RS12	52.8(2.08)	15.7(0.62)	24.4(0.96)	15.1(0.59)	30.0(1.18)	35.0(1.38)	32.0(1.26)
20	1/2	-MC-MT20-RS8	50.5(1.99)	14.2(0.56)	26.0(1.02)	11.9(0.47)	32.0(1.26)	30.0(1.18)	25.9(1.02)
20	3/4	-MC-MT20-RS12	52.8(2.08)	15.7(0.62)	26.0(1.02)	15.9(0.63)	32.0(1.26)	35.0(1.38)	32.0(1.26)
22	3/4	-MC-MT22-RS12	52.8(2.08)	15.7(0.62)	26.0(1.02)	15.9(0.63)	32.0(1.26)	35.0(1.38)	32.0(1.26)
22	1	-MC-MT22-RS16	55.3(2.18)	18.3(0.72)	26.0(1.02)	18.3(0.72)	32.0(1.26)	41.0(1.61)	39.1(1.54)
25	3/4	-MC-MT25-RS12	57.5(2.26)	15.7(0.62)	31.3(1.23)	15.9(0.63)	38.0(1.50)	35.0(1.38)	32.0(1.26)
25	1	-MC-MT25-RS16	60.1(2.37)	18.3(0.72)	31.3(1.23)	19.8(0.78)	38.0(1.50)	41.0(1.61)	39.1(1.54)
28	1	-MC-MT28-RS16	70.1(2.76)	18.3(0.72)	36.6(1.44)	19.8(0.78)	46.0(1.81)	41.0(1.61)	39.1(1.54)
28	1 1/4	-MC-MT28-RS20	73.9(2.91)	19.8(0.78)	36.6(1.44)	21.8(0.86)	46.0(1.81)	50.0(1.97)	49.0(1.93)
30	1 1/4	-MC-MT30-RS20	76.5(3.01)	19.8(0.78)	39.6(1.56)	25.0(0.98)	50.0(1.97)	50.0(1.97)	49.0(1.93)
32	1 1/4	-MC-MT32-RS20	78.9(3.11)	19.8(0.78)	42.0(1.65)	25.0(0.98)	50.0(1.97)	50.0(1.97)	49.0(1.93)
38	1 1/2	-MC-MT38-RS24	90.8(3.57)	22.1(0.87)	49.4(1.94)	31.8(1.25)	60.0(2.36)	55.0(2.17)	54.7(2.15)

Male Connector

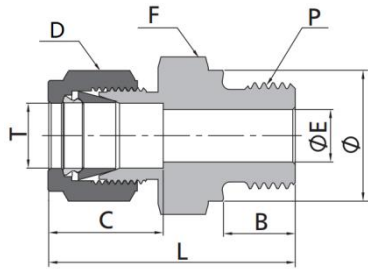

Metric Tube to ISO Parallel Thread

T-Tube O.D. (mm)	P-RP Size	Basic Ordering Number	Dimension, mm. (in.)						
			L	B	C	E	D	F	G
3	1/8	-MC-MT3-RP2	30.0(1.18)	7.1(0.28)	12.9(0.51)	2.4(0.09)	12.0(0.47)	14.0(0.55)	13.8(0.54)
4	1/8	-MC-MT4-RP2	30.7(1.21)	7.1(0.28)	13.7(0.54)	2.4(0.09)	12.0(0.47)	14.0(0.55)	13.8(0.54)
6	1/4	-MC-MT6-RP4	37.6(1.48)	11.2(0.44)	15.3(0.60)	4.8(0.19)	14.0(0.55)	19.0(0.75)	18.0(0.71)
8	1/4	-MC-MT8-RP4	38.5(1.52)	11.2(0.44)	16.2(0.64)	5.9(0.23)	16.0(0.63)	19.0(0.75)	18.0(0.71)
10	3/8	-MC-MT10-RP6	40.6(1.60)	11.2(0.44)	17.2(0.68)	7.9(0.31)	19.0(0.75)	22.0(0.87)	21.8(0.86)
12	3/8	-MC-MT12-RP6	43.1(1.70)	11.2(0.44)	22.8(0.90)	7.9(0.31)	22.0(0.87)	22.0(0.87)	21.8(0.86)
12	1/2	-MC-MT12-RP8	49.0(1.93)	14.2(0.56)	22.8(0.90)	9.5(0.37)	22.0(0.87)	27.0(1.06)	26.0(1.02)
15	1/2	-MC-MT15-RP8	49.0(1.93)	14.2(0.56)	24.4(0.96)	11.9(0.47)	25.0(0.98)	27.0(1.06)	26.0(1.02)
16	1/2	-MC-MT16-RP8	49.0(1.93)	14.2(0.56)	24.4(0.96)	11.9(0.47)	25.0(0.98)	27.0(1.06)	26.0(1.02)
18	1/2	-MC-MT18-RP8	49.0(1.93)	14.2(0.56)	24.4(0.96)	11.9(0.47)	30.0(1.18)	27.0(1.06)	26.0(1.02)
20	3/4	-MC-MT20-RP12	52.8(2.08)	15.7(0.62)	26.0(1.02)	15.9(0.63)	32.0(1.26)	35.0(1.38)	32.0(1.26)
22	3/4	-MC-MT22-RP12	52.8(2.08)	15.7(0.62)	26.0(1.02)	15.9(0.63)	32.0(1.26)	35.0(1.38)	32.0(1.26)
25	1	-MC-MT25-RP16	60.1(2.37)	18.3(0.72)	31.3(1.23)	19.8(0.78)	38.0(1.50)	41.0(1.61)	39.0(1.54)
28	1	-MC-MT28-RP16	70.1(2.76)	18.3(0.72)	36.6(1.44)	19.8(0.78)	46.0(1.81)	41.0(1.61)	39.0(1.54)
28	1 1/4	-MC-MT28-RP20	73.9(2.91)	19.8(0.78)	36.6(1.44)	21.8(0.86)	46.0(1.81)	50.0(1.97)	49.0(1.93)
30	1 1/4	-MC-MT30-RP20	76.5(3.01)	19.8(0.78)	39.6(1.56)	26.2(1.03)	50.0(1.97)	50.0(1.97)	49.0(1.93)
32	1 1/4	-MC-MT32-RP20	78.9(3.11)	19.8(0.78)	42.0(1.65)	28.6(1.13)	50.0(1.97)	50.0(1.97)	49.0(1.93)
38	1 1/2	-MC-MT38-RP24	89.3(3.52)	20.6(0.81)	49.4(1.94)	31.8(1.25)	60.0(2.36)	55.0(2.17)	54.7(2.15)

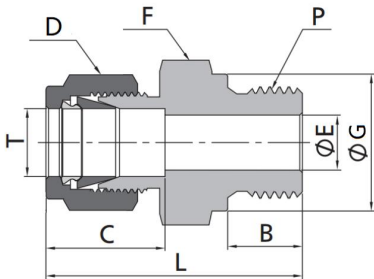

Metric Tube to Metric Thread

T-Tube O.D. (mm)	P-Metric Size	Basic Ordering Number	Dimension, mm(in.)						
			L	B	C	E	D	F	G
6	M8x 1	-MC-MT6-MS8	33.3(1.31)	8.0(0.31)	15.3(0.60)	3.0(0.12)	14.0(0.55)	14.0(0.55)	12.0(0.47)
6	M10x 1	-MC-MT6-MS10	33.3(1.31)	8.0(0.31)	15.3(0.60)	4.0(0.16)	14.0(0.55)	14.0(0.55)	14.0(0.55)
8	M10x 1	-MC-MT8-MS10	34.1(1.34)	8.0(0.31)	16.2(0.64)	5.0(0.20)	16.0(0.63)	15.0(0.59)	14.0(0.55)
8	M12x 1.5	-MC-MT8-MS12	40.4(1.59)	12.0(0.47)	16.2(0.64)	6.0(0.24)	16.0(0.63)	18.0(0.71)	17.0(0.67)
10	M12x 1.5	-MC-MT10-MS12	40.7(1.60)	12.0(0.47)	17.2(0.68)	6.0(0.24)	19.0(0.75)	18.0(0.71)	17.0(0.67)
10	M14x 1.5	-MC-MT10-MS14	41.5(1.63)	12.0(0.47)	17.2(0.68)	7.9(0.31)	19.0(0.75)	19.0(0.75)	19.0(0.75)
12	M16x 1.5	-MC-MT12-MS16	45.5(1.79)	12.0(0.47)	22.8(0.90)	9.0(0.35)	22.0(0.87)	22.0(0.87)	21.0(0.83)
12	M20x 1.5	-MC-MT12-MS20	48.0(1.89)	14.0(0.55)	22.8(0.90)	9.5(0.37)	22.0(0.87)	25.0(0.98)	25.0(0.98)
14	M20x 1.5	-MC-MT14-MS20	48.0(1.89)	14.0(0.55)	24.4(0.96)	11.1(0.44)	25.0(0.98)	25.0(0.98)	25.0(0.98)
16	M20x 1.5	-MC-MT16-MS20	48.0(1.89)	14.0(0.55)	24.4(0.96)	12.0(0.47)	25.0(0.98)	25.0(0.98)	25.0(0.98)
18	M20x 1.5	-MC-MT18-MS20	48.5(1.91)	14.0(0.55)	24.4(0.96)	12.0(0.47)	30.0(1.18)	27.0(1.06)	25.0(0.98)
20	M20x 1.5	-MC-MT20-MS20	50.0(1.97)	14.0(0.55)	26.0(1.02)	12.0(0.47)	32.0(1.26)	30.0(1.18)	25.0(0.98)
22	M24x 1.5	-MC-MT22-MS24	50.5(1.99)	14.0(0.55)	26.0(1.02)	15.0(0.59)	32.0(1.26)	30.0(1.18)	32.0(1.26)
25	M27x2	-MC-MT25-MS27	57.5(2.26)	16.0(0.63)	31.3(1.23)	16.8(0.66)	38.0(1.50)	35.0(1.38)	32.0(1.26)

Thermocouple Connectors

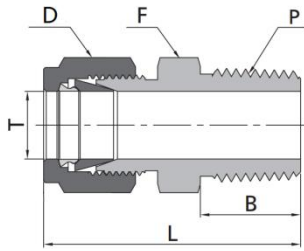

Fractional Tube to NPT Thread

T-Tube O.D. (in.)	P-NPT Size	Basic Ordering Number	Dimension, in. (mm)			
			L	B	C	D
1/16	1/16	-TMC-FT1-MN1	0.94(23.9)	0.38(9.7)	0.31(7.9)	0.31(7.9)
1/16	1/8	-TMC-FT1-MN2	1.03(26.2)	0.38(9.7)	0.31(7.9)	0.44(11.1)
1/8	1/16	-TMC-FT2-MN1	1.17(29.7)	0.38(9.7)	0.44(11.1)	0.44(11.1)
1/8	1/8	-TMC-FT2-MN2	1.20(30.5)	0.38(9.7)	0.44(11.1)	0.44(11.1)
1/8	1/4	-TMC-FT2-MN4	1.40(35.6)	0.56(14.2)	0.44(11.1)	0.56(14.3)
3/16	1/8	-TMC-FT3-MN2	1.23(31.2)	0.38(9.7)	0.50(12.7)	0.44(11.1)
3/16	1/4	-TMC-FT3-MN4	1.43(36.3)	0.56(14.2)	0.50(12.7)	0.56(14.3)
1/4	1/8	-TMC-FT4-MN2	1.29(32.8)	0.38(9.7)	0.56(14.3)	0.50(12.7)
1/4	1/4	-TMC-FT4-MN4	1.49(37.8)	0.56(14.2)	0.56(14.3)	0.56(14.3)
1/4	3/8	-TMC-FT4-MN6	1.51(38.4)	0.56(14.2)	0.56(14.3)	0.69(17.5)
1/4	1/2	-TMC-FT4-MN8	1.76(44.7)	0.75(19.1)	0.56(14.3)	0.87(22.2)
5/16	1/4	-TMC-FT5-MN4	1.52(38.6)	0.56(14.2)	0.63(15.9)	0.56(14.3)
3/8	1/4	-TMC-FT6-MN4	1.57(39.9)	0.56(14.2)	0.69(17.5)	0.63(15.9)
3/8	3/8	-TMC-FT6-MN6	1.57(39.9)	0.56(14.2)	0.69(17.5)	0.69(17.5)
3/8	1/2	-TMC-FT6-MN8	1.82(46.2)	0.75(19.1)	0.69(17.5)	0.87(22.2)
1/2	1/2	-TMC-FT8-MN8	1.93(49.0)	0.75(19.1)	0.87(22.2)	0.87(22.2)
1/2	3/4	-TMC-FT8-MN12	1.99(50.5)	0.75(19.1)	0.87(22.2)	1.06(27.0)
5/8	3/4	-TMC-FT10-MN12	1.99(50.5)	0.75(19.1)	1.00(25.4)	1.06(27.0)
3/4	3/4	-TMC-FT12-MN12	1.99(50.5)	0.75(19.1)	1.13(28.6)	1.06(27.0)
1	1	-TMC-FT16-MN16	2.45(62.2)	0.94(23.9)	1.50(38.1)	1.37(34.9)

Metric Tube to NPT Thread

T-Tube O.D. (mm)	P-NPT Size	Basic Ordering Number	Dimension, mm. (in.)			
			L	B	C	D
2	1/8	-TMC-MT2-MN2	30.5(1.20)	9.7(0.38)	12.0(0.47)	12.0(0.47)
3	1/8	-TMC-MT3-MN2	30.5(1.20)	9.7(0.38)	12.0(0.47)	12.0(0.47)
3	1/4	-TMC-MT3-MN4	35.6(1.40)	14.2(0.56)	12.0(0.47)	14.0(0.55)
4	1/8	-TMC-MT4-MN2	31.2(1.23)	9.7(0.38)	12.0(0.47)	12.0(0.47)
4	1/4	-TMC-MT4-MN4	36.3(1.43)	14.2(0.56)	12.0(0.47)	14.0(0.55)
6	1/8	-TMC-MT6-MN2	32.8(1.29)	9.7(0.38)	14.0(0.55)	14.0(0.55)
6	1/4	-TMC-MT6-MN4	37.9(1.49)	14.2(0.56)	14.0(0.55)	14.0(0.55)
8	1/4	-TMC-MT8-MN4	38.7(1.52)	14.2(0.56)	16.0(0.63)	15.0(0.59)
8	3/8	-TMC-MT8-MN6	39.3(1.55)	14.2(0.56)	16.0(0.63)	18.0(0.71)
10	3/8	-TMC-MT10-MN6	40.9(1.61)	14.2(0.56)	19.0(0.75)	18.0(0.71)
10	1/2	-TMC-MT10-MN8	46.5(1.83)	19.1(0.75)	19.0(0.75)	22.0(0.87)
12	3/8	-TMC-MT12-MN6	43.4(1.71)	14.2(0.56)	22.0(0.87)	22.0(0.87)
12	1/2	-TMC-MT12-MN8	49.0(1.93)	19.1(0.75)	22.0(0.87)	22.0(0.87)
12	3/4	-TMC-MT12-MN12	50.5(1.99)	19.1(0.75)	22.0(0.87)	27.0(1.06)
14	1/2	-TMC-MT14-MN8	49.0(1.93)	19.1(0.75)	25.0(0.98)	24.0(0.94)
14	3/4	-TMC-MT14-MN12	50.5(1.99)	19.1(0.75)	25.0(0.98)	27.0(1.06)
15	1/2	-TMC-MT15-MN8	49.0(1.93)	19.1(0.75)	25.0(0.98)	24.0(0.94)

Female Connector

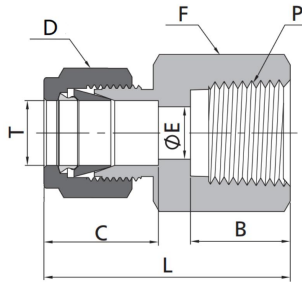

Fractional Tube to NPT Thread

T-Tube O.D. (in.)	P-NPT Size	Basic Ordering Number	Dimension, in(mm)					
			L	B	C	E	D	F
1/16	1/16	-FC-FT1-FN1	0.93(23.6)	0.39(9.9)	0.34(8.6)	0.05(1.3)	0.31(7.9)	0.44(11.1)
1/16	1/8	-FC-FT1-FN2	0.96(24.4)	0.41(10.4)	0.34(8.6)	0.05(1.3)	0.31(7.9)	0.56(14.3)
1/8	1/8	-FC-FT2-FN2	1.13(28.7)	0.41(10.4)	0.50(12.7)	0.09(2.3)	0.44(11.1)	0.56(14.3)
1/8	1/4	-FC-FT2-FN4	1.32(33.5)	0.59(15.0)	0.50(12.7)	0.09(2.3)	0.44(11.1)	0.75(19.1)
3/16	1/8	-FC-FT3-FN2	1.17(29.7)	0.41(10.4)	0.54(13.7)	0.12(3.0)	0.50(12.7)	0.56(14.3)
1/4	1/8	-FC-FT4-FN2	1.23(31.2)	0.41(10.4)	0.60(15.2)	0.19(4.8)	0.56(14.3)	0.56(14.3)
1/4	1/4	-FC-FT4-FN4	1.41(35.8)	0.59(15.0)	0.60(15.2)	0.19(4.8)	0.56(14.3)	0.75(19.1)
1/4	3/8	-FC-FT4-FN6	1.48(37.6)	0.59(15.0)	0.60(15.2)	0.19(4.8)	0.56(14.3)	0.87(22.2)
5/16	1/8	-FC-FT5-FN2	1.26(32.0)	0.41(10.4)	0.64(16.3)	0.25(6.4)	0.63(15.9)	0.56(14.3)
5/16	1/4	-FC-FT5-FN4	1.45(36.8)	0.59(15.0)	0.64(16.3)	0.25(6.4)	0.63(15.9)	0.75(19.1)
3/8	1/8	-FC-FT6-FN2	1.29(32.8)	0.41(10.4)	0.66(16.8)	0.28(7.1)	0.69(17.5)	0.63(15.9)
3/8	1/4	-FC-FT6-FN4	1.48(37.6)	0.59(15.0)	0.66(16.8)	0.28(7.1)	0.69(17.5)	0.75(19.1)
3/8	3/8	-FC-FT6-FN6	1.54(39.1)	0.59(15.0)	0.66(16.8)	0.28(7.1)	0.69(17.5)	0.87(22.0)
3/8	1/2	-FC-FT6-FN8	1.73(43.9)	0.78(19.8)	0.66(16.8)	0.28(7.1)	0.69(17.5)	1.06(27.0)
1/2	1/4	-FC-FT8-FN4	1.59(40.4)	0.59(15.0)	0.90(22.9)	0.41(10.4)	0.87(22.2)	0.81(20.6)
1/2	3/8	-FC-FT8-FN6	1.65(41.9)	0.59(15.0)	0.90(22.9)	0.41(10.4)	0.87(22.2)	0.87(22.2)
1/2	1/2	-FC-FT8-FN8	1.84(46.7)	0.78(19.8)	0.90(22.9)	0.41(10.4)	0.87(22.2)	1.06(27.0)
1/2	3/4	-FC-FT8-FN12	1.90(48.3)	0.81(20.6)	0.90(22.9)	0.41(10.4)	0.87(22.2)	1.31(33.3)
5/8	1/2	-FC-FT10-FN8	1.84(46.7)	0.78(19.8)	0.96(24.4)	0.50(12.7)	1.00(25.4)	1.06(27.0)
3/4	1/2	-FC-FT12-FN8	1.84(46.7)	0.78(19.8)	0.96(24.4)	0.62(15.7)	1.13(28.6)	1.06(27.0)
3/4	3/4	-FC-FT12-FN12	1.90(48.3)	0.81(20.6)	0.96(24.4)	0.62(15.7)	1.13(28.6)	1.31(33.3)
7/8	3/4	-FC-FT14-FN12	1.96(49.8)	0.81(20.6)	1.02(25.9)	0.72(18.3)	1.25(31.8)	1.31(33.3)
1	3/4	-FC-FT16-FN12	2.10(53.3)	0.81(20.6)	1.23(31.2)	0.88(22.4)	1.50(38.1)	1.37(34.9)
1	1	-FC-FT16-FN16	2.45(62.2)	1.00(25.4)	1.23(31.2)	0.88(22.4)	1.50(38.1)	1.63(41.3)
1 1/4	1 1/4	-FC-FT20-FN20	2.94(74.7)	1.00(25.4)	1.62(41.1)	1.09(27.7)	1.87(47.6)	2.13(54.0)
1 1/2	1 1/2	-FC-FT24-FN24	3.30(83.8)	1.09(27.7)	1.97(50.0)	1.43(36.3)	2.25(57.2)	2.37(60.3)

Fractional Tube to RT Thread

T-Tube O.D. (in.)	P-RT Size	Basic Ordering Number	Dimension, in(mm)					
			L	B	C	E	D	F
1/4	1/8	-FC-FT4-FR2	1.23(31.2)	0.41(10.4)	0.60(15.2)	0.19(4.8)	0.56(14.3)	0.56(14.3)
1/4	1/4	-FC-FT4-FR4	1.41(35.8)	0.59(15.0)	0.60(15.2)	0.19(4.8)	0.56(14.3)	0.75(19.1)
1/4	3/8	-FC-FT4-FR6	1.48(37.6)	0.59(15.0)	0.60(15.2)	0.19(4.8)	0.56(14.3)	0.87(22.2)
1/4	1/2	-FC-FT4-FR8	1.67(42.4)	0.78(19.8)	0.60(15.2)	0.19(4.8)	0.56(14.3)	1.06(27.0)
3/8	1/4	-FC-FT6-FR4	1.48(37.6)	0.59(15.0)	0.66(16.8)	0.28(7.1)	0.69(17.5)	0.75(19.1)
3/8	3/8	-FC-FT6-FR6	1.54(39.1)	0.59(15.0)	0.66(16.8)	0.28(7.1)	0.69(17.5)	0.87(22.2)
3/8	1/2	-FC-FT6-FR8	1.73(43.9)	0.78(19.8)	0.66(16.8)	0.28(7.1)	0.69(17.5)	1.06(27.0)
1/2	1/4	-FC-FT8-FR4	1.59(40.4)	0.59(15.0)	0.90(22.9)	0.41(10.4)	0.87(22.2)	0.81(20.6)
1/2	3/8	-FC-FT8-FR6	1.65(41.9)	0.59(15.0)	0.90(22.9)	0.41(10.4)	0.87(22.2)	0.87(22.2)
1/2	1/2	-FC-FT8-FR8	1.84(46.7)	0.78(19.8)	0.90(22.9)	0.41(10.4)	0.87(22.2)	1.06(27.0)

Female Connector

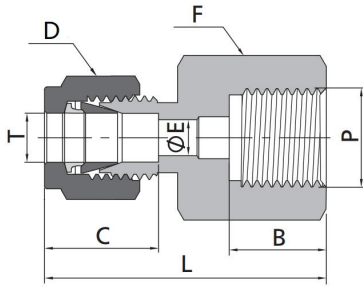

Fractional Tube to ISO Parallel Thread

T-Tube O.D. (in.)	P-RG Size	Basic Ordering Number	Dimension, in(mm)					
			L	B	C	E	D	F
1/8	1/4	-FC-FT2-FG4	1.39(35.3)	0.51(12.9)	0.50(12.7)	0.09(2.3)	0.44(11.1)	0.75(19.1)
1/8	3/8	-FC-FT2-FG6	1.52(38.7)	0.56(14.2)	0.50(12.7)	0.09(2.3)	0.44(11.1)	0.94(23.8)
1/4	1/4	-FC-FT4-FG4	1.48(37.6)	0.51(12.9)	0.60(15.2)	0.19(4.8)	0.56(14.3)	0.75(19.1)
1/4	3/8	-FC-FT4-FG6	1.48(37.6)	0.56(14.2)	0.60(15.2)	0.19(4.8)	0.56(14.3)	0.94(23.8)
1/4	1/2	-FC-FT4-FG8	1.71(43.4)	0.74(18.8)	0.60(15.2)	0.19(4.8)	0.56(14.3)	1.06(27.0)
5/16	1/4	-FC-FT5-FG4	1.51(38.4)	0.51(12.9)	0.64(16.3)	0.22(5.6)	0.63(15.9)	0.75(19.1)
5/16	3/8	-FC-FT5-FG6	1.54(39.2)	0.56(14.2)	0.64(16.3)	0.25(6.4)	0.63(15.9)	0.94(23.8)
5/16	1/2	-FC-FT5-FG8	1.61(40.9)	0.74(18.8)	0.64(16.3)	0.28(7.1)	0.63(15.9)	1.06(27.0)
3/8	1/4	-FC-FT6-FG4	1.54(39.1)	0.51(12.9)	0.66(16.8)	0.22(5.6)	0.69(17.5)	0.75(19.1)
3/8	3/8	-FC-FT6-FG6	1.52(38.6)	0.56(14.2)	0.66(16.8)	0.21(5.4)	0.69(17.5)	0.94(23.8)
3/8	1/2	-FC-FT6-FG8	1.65(41.9)	0.74(18.8)	0.66(16.8)	0.28(7.1)	0.69(17.5)	1.06(27.0)
1/2	1/4	-FC-FT8-FG4	1.65(41.9)	0.51(12.9)	0.90(22.9)	0.22(5.6)	0.87(22.2)	0.87(22.2)
1/2	3/8	-FC-FT8-FG6	1.75(44.5)	0.56(14.2)	0.90(22.9)	0.25(6.4)	0.87(22.2)	0.94(23.8)
1/2	1/2	-FC-FT8-FG8	1.90(48.3)	0.74(18.8)	0.90(22.9)	0.28(7.1)	0.87(22.2)	1.06(27.0)

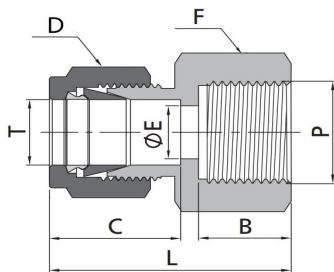

Fractional Tube to Metric Thread

T-Tube O.D. (in.)	P-RG Size	Basic Ordering Number	Dimension, in(mm)					
			L	B	C	E	D	F
1/8	M14 x 1.5	-FC-FT2-FM14	1.27(32.3)	0.51(13.0)	0.50(12.7)	0.09(2.3)	0.44(11.1)	0.75(19.1)
1/8	M16 x 1.5	-FC-FT2-FM16	1.31(33.3)	0.55(14.0)	0.50(12.7)	0.09(2.3)	0.44(11.1)	0.87(22.2)
1/8	M18 x 1.5	-FC-FT2-FM18	1.35(34.3)	0.59(15.0)	0.50(12.7)	0.09(2.3)	0.44(11.1)	1.00(25.4)
1/4	M16 x 1.5	-FC-FT4-FM16	1.41(35.8)	0.55(14.0)	0.60(15.2)	0.19(4.8)	0.56(14.3)	0.87(22.2)
1/4	M18 x 1.5	-FC-FT4-FM18	1.45(36.8)	0.59(15.0)	0.60(15.2)	0.19(4.8)	0.56(14.3)	1.00(25.4)
1/4	M20 x 1.5	-FC-FT4-FM20	1.49(37.8)	0.63(16.0)	0.60(15.2)	0.19(4.8)	0.56(14.3)	1.06(27.0)
3/8	M14 x 1.5	-FC-FT6-FM14	1.46(37.1)	0.51(13.0)	0.66(16.8)	0.28(7.1)	0.69(17.5)	0.75(19.1)
3/8	M16 x 1.5	-FC-FT6-FM16	1.48(37.5)	0.55(14.0)	0.66(16.8)	0.28(7.1)	0.69(17.5)	0.87(22.2)
3/8	M18 x 1.5	-FC-FT6-FM18	1.52(38.5)	0.59(15.0)	0.66(16.8)	0.28(7.1)	0.69(17.5)	1.00(25.4)
3/8	M20 x 1.5	-FC-FT6-FM20	1.56(39.5)	0.63(16.0)	0.66(16.8)	0.28(7.1)	0.69(17.5)	1.06(27.0)
1/2	M16 x 1.5	-FC-FT8-FM16	1.63(41.4)	0.55(14.0)	0.90(22.9)	0.33(8.4)	0.87(22.2)	0.87(22.2)
1/2	M18 x 1.5	-FC-FT8-FM18	1.67(42.4)	0.59(15.0)	0.90(22.9)	0.38(9.6)	0.87(22.2)	1.00(25.4)
1/2	M20 x 1.5	-FC-FT8-FM20	1.71(43.4)	0.63(16.0)	0.90(22.9)	0.41(10.4)	0.87(22.2)	1.06(27.0)
1/2	M22 x 1.5	-FC-FT8-FM22	1.75(44.4)	0.67(17.0)	0.90(22.9)	0.41(10.4)	0.87(22.2)	1.06(27.0)

Female Connector

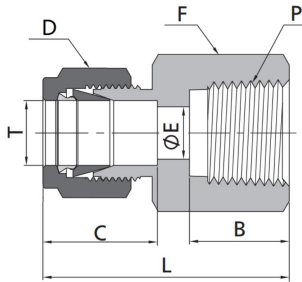

Metric Tube to NPT Thread

T-Tube O.D. (mm)	P-NPT Size	Basic Ordering Number	Dimension,mm(in.)					
			L	B	C	E	D	F
3	1/8	-FC-MT3-FN2	28.7(1.13)	10.4(0.41)	12.9(0.51)	2.4(0.09)	12.0(0.47)	14.0(0.55)
3	1/4	-FC-MT3-FN4	33.5(1.32)	15.0(0.59)	12.9(0.51)	2.4(0.09)	12.0(0.47)	19.0(0.75)
4	1/8	-FC-MT4-FN2	29.7(1.17)	10.4(0.41)	13.7(0.54)	2.4(0.09)	12.0(0.47)	14.0(0.55)
6	1/8	-FC-MT6-FN2	31.3(1.23)	10.4(0.41)	15.3(0.60)	4.8(0.19)	14.0(0.55)	14.0(0.55)
6	1/4	-FC-MT6-FN4	35.8(1.41)	15.0(0.59)	15.3(0.60)	4.8(0.19)	14.0(0.55)	19.0(0.75)
6	3/8	-FC-MT6-FN6	37.7(1.48)	15.0(0.59)	15.3(0.60)	4.8(0.19)	14.0(0.55)	22.0(0.87)
6	1/2	-FC-MT6-FN8	42.5(1.67)	19.8(0.78)	15.3(0.60)	4.8(0.19)	14.0(0.55)	27.0(1.06)
8	1/8	-FC-MT8-FN2	32.1(1.26)	10.4(0.41)	16.2(0.64)	4.8(0.19)	16.0(0.63)	15.0(0.59)
8	1/4	-FC-MT8-FN4	37.0(1.46)	15.0(0.59)	16.2(0.64)	6.4(0.25)	16.0(0.63)	19.0(0.75)
8	3/8	-FC-MT8-FN6	38.5(1.52)	15.0(0.59)	16.2(0.64)	6.4(0.25)	16.0(0.63)	22.0(0.87)
8	1/2	-FC-MT8-FN8	43.3(1.70)	19.8(0.78)	16.2(0.64)	6.4(0.25)	16.0(0.63)	27.0(1.06)
10	1/8	-FC-MT10-FN2	33.0(1.30)	10.4(0.41)	17.2(0.68)	4.8(0.19)	19.0(0.75)	15.0(0.59)
10	1/4	-FC-MT10-FN4	37.8(1.49)	15.0(0.59)	17.2(0.68)	7.9(0.31)	19.0(0.75)	19.0(0.75)
10	3/8	-FC-MT10-FN6	39.4(1.55)	15.0(0.59)	17.2(0.68)	7.9(0.31)	19.0(0.75)	22.0(0.87)
10	1/2	-FC-MT10-FN8	44.2(1.74)	19.8(0.78)	17.2(0.68)	7.9(0.31)	19.0(0.75)	27.0(1.06)
12	1/4	-FC-MT12-FN4	40.3(1.59)	15.0(0.59)	22.8(0.90)	7.9(0.31)	22.0(0.87)	22.0(0.87)
12	3/8	-FC-MT12-FN6	41.9(1.65)	15.0(0.59)	22.8(0.90)	9.5(0.37)	22.0(0.87)	22.0(0.87)
12	1/2	-FC-MT12-FN8	46.7(1.84)	19.8(0.78)	22.8(0.90)	9.5(0.37)	22.0(0.87)	27.0(1.06)
12	3/4	-FC-MT12-FN12	49.7(1.96)	20.6(0.81)	22.8(0.90)	9.5(0.37)	22.0(0.87)	35.0(1.38)
14	3/4	-FC-MT14-FN12	49.7(1.96)	20.6(0.81)	24.4(0.96)	11.1(0.44)	25.0(0.98)	35.0(1.38)
15	1/2	-FC-MT15-FN8	46.7(1.84)	19.8(0.78)	24.4(0.96)	11.9(0.47)	25.0(0.98)	27.0(1.06)
16	3/8	-FC-MT16-FN6	41.9(1.65)	15.0(0.59)	24.4(0.96)	9.5(0.37)	25.0(0.98)	27.0(1.06)
16	1/2	-FC-MT16-FN8	46.9(1.85)	19.8(0.78)	24.4(0.96)	11.9(0.47)	25.0(0.98)	27.0(1.06)
20	1/2	-FC-MT20-FN8	47.9(1.89)	19.8(0.78)	26.0(1.02)	11.9(0.47)	32.0(1.26)	30.0(1.18)
20	3/4	-FC-MT20-FN12	49.7(1.96)	20.6(0.81)	26.0(1.02)	15.9(0.63)	32.0(1.26)	35.0(1.38)
22	3/4	-FC-MT22-FN12	49.7(1.96)	20.6(0.81)	26.0(1.02)	15.9(0.63)	32.0(1.26)	35.0(1.38)
22	1	-FC-MT22-FN16	57.9(2.28)	25.4(1.00)	26.0(1.02)	18.3(0.72)	32.0(1.26)	41.0(1.61)
25	3/4	-FC-MT25-FN12	53.4(2.10)	20.6(0.81)	31.3(1.23)	15.9(0.63)	38.0(1.50)	35.0(1.38)
25	1	-FC-MT25-FN16	62.3(2.45)	25.4(1.00)	31.3(1.23)	21.8(0.86)	38.0(1.50)	41.0(1.61)

Female Connector

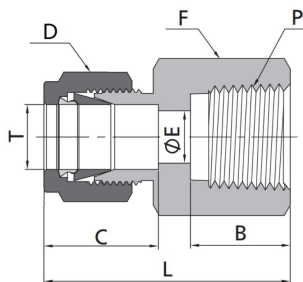

Metric Tube to RT Thread

T-Tube O.D. (mm)	P-RT Size	Basic Ordering Number	Dimension,mm(in.)					
			L	B	C	E	D	F
3	1/8	-FC-MT3-FR2	28.7(1.13)	10.4(0.41)	12.9(0.51)	2.4(0.09)	12.0(0.47)	14.0(0.55)
6	1/8	-FC-MT6-FR2	31.3(1.23)	10.4(0.41)	15.3(0.60)	4.8(0.19)	14.0(0.55)	14.0(0.55)
6	1/4	-FC-MT6-FR4	35.8(1.41)	15.0(0.59)	15.3(0.60)	4.8(0.19)	14.0(0.55)	19.0(0.75)
6	3/8	-FC-MT6-FR6	36.9(1.45)	15.0(0.59)	15.3(0.60)	4.8(0.19)	14.0(0.55)	22.0(0.87)
6	1/2	-FC-MT6-FR8	42.5(1.67)	19.8(0.78)	15.3(0.60)	4.8(0.19)	14.0(0.55)	27.0(1.06)
8	1/8	-FC-MT8-FR2	32.1(1.26)	10.4(0.41)	16.2(0.64)	6.4(0.25)	16.0(0.63)	15.0(0.59)
8	1/4	-FC-MT8-FR4	37.0(1.46)	15.0(0.59)	16.2(0.64)	6.4(0.25)	16.0(0.63)	19.0(0.75)
8	3/8	-FC-MT8-FR6	38.5(1.52)	15.0(0.59)	16.2(0.64)	6.4(0.25)	16.0(0.63)	22.0(0.87)
8	1/2	-FC-MT8-FR8	43.3(1.70)	19.8(0.78)	16.2(0.64)	6.4(0.25)	16.0(0.63)	27.0(1.06)
10	1/8	-FC-MT10-FR2	33.0(1.30)	10.4(0.41)	17.2(0.68)	7.9(0.31)	19.0(0.75)	18.0(0.71)
10	1/4	-FC-MT10-FR4	37.8(1.49)	15.0(0.59)	17.2(0.68)	7.9(0.31)	19.0(0.75)	19.0(0.75)
10	3/8	-FC-MT10-FR6	39.4(1.55)	15.0(0.59)	17.2(0.68)	7.9(0.31)	19.0(0.75)	22.0(0.87)
10	1/2	-FC-MT10-FR8	44.2(1.74)	19.8(0.78)	17.2(0.68)	7.9(0.31)	19.0(0.75)	27.0(1.06)
12	1/8	-FC-MT12-FR2	35.5(1.40)	10.4(0.41)	22.8(0.90)	8.3(0.33)	22.0(0.87)	22.0(0.87)
12	1/4	-FC-MT12-FR4	40.3(1.59)	15.0(0.59)	22.8(0.90)	9.5(0.37)	22.0(0.87)	22.0(0.87)
12	3/8	-FC-MT12-FR6	41.9(1.65)	15.0(0.59)	22.8(0.90)	9.5(0.37)	22.0(0.87)	22.0(0.87)
12	1/2	-FC-MT12-FR8	46.7(1.84)	19.8(0.78)	22.8(0.90)	9.5(0.37)	22.0(0.87)	27.0(1.06)
12	3/4	-FC-MT12-FR12	49.0(1.93)	20.6(0.81)	22.8(0.90)	9.5(0.37)	22.0(0.87)	35.0(1.38)
15	1/2	-FC-MT15-FR8	46.7(1.84)	19.8(0.78)	24.4(0.96)	11.9(0.47)	25.0(0.98)	27.0(1.06)
16	1/2	-FC-MT16-FR8	48.4(1.91)	19.8(0.78)	24.4(0.96)	11.9(0.47)	25.0(0.98)	27.0(1.06)
16	3/4	-FC-MT16-FR12	49.7(1.96)	20.6(0.81)	24.4(0.96)	12.7(0.5)	25.0(0.98)	35.0(1.38)
20	1/2	-FC-MT20-FR8	47.9(1.89)	19.8(0.78)	26.0(1.02)	11.9(0.47)	32.0(1.26)	30.0(1.18)
20	3/4	-FC-MT20-FR12	49.7(1.96)	20.6(0.81)	26.0(1.02)	15.9(0.63)	32.0(1.26)	35.0(1.38)
22	3/4	-FC-MT22-FR12	49.7(1.96)	20.6(0.81)	26.0(1.02)	15.9(0.63)	32.0(1.26)	35.0(1.38)
22	1	-FC-MT22-FR16	57.9(2.28)	25.4(1.00)	26.0(1.02)	18.3(0.72)	32.0(1.26)	41.0(1.61)
25	3/4	-FC-MT25-FR12	53.4(2.10)	20.6(0.81)	31.3(1.23)	15.9(0.63)	38.0(1.50)	35.0(1.38)
25	1	-FC-MT25-FR16	62.3(2.45)	25.4(1.00)	31.3(1.23)	21.8(0.86)	38.0(1.50)	41.0(1.61)
25	3/4	-FC-MT25-FN12	53.4(2.10)	20.6(0.81)	31.3(1.23)	15.9(0.63)	38.0(1.50)	35.0(1.38)
25	1	-FC-MT25-FN16	62.3(2.45)	25.4(1.00)	31.3(1.23)	21.8(0.86)	38.0(1.50)	41.0(1.61)

Female Connector

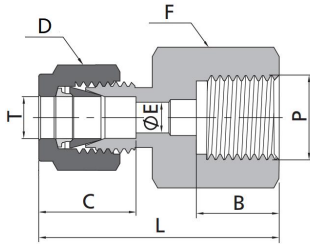

Metric Tube to ISO Parallel Thread

T-Tube O.D. (in.)	P-RG Size	Basic Ordering Number	Dimension,mm(in.)					
			L	B	C	E	D	F
3	1/4	-FC-MT3-FG4	35.3(1.39)	12.9(0.51)	12.9(0.51)	2.4(0.09)	12.0(0.47)	19.0(0.75)
6	1/4	-FC-MT6-FG4	37.6(1.48)	12.9(0.51)	15.3(0.60)	4.8(0.19)	14.0(0.55)	19.0(0.75)
6	3/8	-FC-MT6-FG6	37.6(1.48)	14.2(0.56)	15.3(0.60)	4.8(0.19)	14.0(0.55)	24.0(0.94)
6	1/2	-FC-MT6-FG8	43.5(1.71)	18.8(0.74)	15.3(0.60)	4.8(0.19)	14.0(0.55)	27.0(1.06)
8	1/4	-FC-MT8-FG4	38.5(1.52)	12.9(0.51)	16.2(0.64)	6.4(0.25)	16.0(0.63)	19.0(0.75)
8	3/8	-FC-MT8-FG6	36.2(1.43)	14.2(0.56)	16.2(0.64)	6.4(0.25)	16.0(0.63)	24.0(0.94)
8	1/2	-FC-MT8-FG8	41.0(1.61)	18.8(0.74)	16.2(0.64)	6.4(0.25)	16.0(0.63)	27.0(1.06)
10	1/4	-FC-MT10-FG4	39.4(1.55)	12.9(0.51)	17.2(0.68)	5.9(0.23)	19.0(0.75)	19.0(0.75)
10	3/8	-FC-MT10-FG6	38.8(1.53)	14.2(0.56)	17.2(0.68)	7.9(0.31)	19.0(0.75)	24.0(0.94)
10	1/2	-FC-MT10-FG8	42.1(1.66)	18.8(0.74)	17.2(0.68)	7.9(0.31)	19.0(0.75)	27.0(1.06)
12	1/4	-FC-MT12-FG4	41.9(1.65)	12.9(0.51)	22.8(0.90)	5.9(0.23)	22.0(0.87)	22.0(0.87)
12	3/8	-FC-MT12-FG6	44.4(1.75)	14.2(0.56)	22.8(0.90)	7.9(0.31)	22.0(0.87)	24.0(0.94)
12	1/2	-FC-MT12-FG8	48.2(1.90)	18.8(0.74)	22.8(0.90)	9.5(0.37)	22.0(0.87)	27.0(1.06)
20	1/2	-FC-MT20-FG8	54.3(2.14)	18.8(0.74)	26.0(1.02)	11.9(0.47)	32.0(1.26)	30.0(1.18)
22	1/2	-FC-MT22-FG8	54.3(2.14)	18.8(0.74)	26.0(1.02)	11.9(0.47)	32.0(1.26)	30.0(1.18)

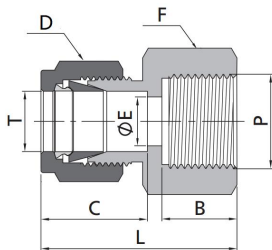

Metric Tube to Metric Thread

T-Tube O.D. (mm)	P-Metric Size	Basic Ordering Number	Dimension,in(mm)					
			L	B	C	E	D	F
6	M10 x 1	-FC-MT6-FM10	32.7(1.29)	11.0(0.43)	15.3(0.60)	4.0(0.16)	14.0(0.55)	16.0(0.63)
6	M14 x 1.5	-FC-MT6-FM14	34.2(1.35)	13.0(0.51)	15.3(0.60)	4.8(0.19)	14.0(0.55)	19.0(0.75)
6	M20 x 1.5	-FC-MT6-FM20	37.7(1.48)	16.0(0.63)	15.3(0.60)	4.8(0.19)	14.0(0.55)	27.0(1.06)
8	M8 x 1	-FC-MT8-FM8	31.6(1.24)	9.0(0.35)	16.2(0.64)	3.2(0.13)	16.0(0.63)	14.0(0.55)
8	M10 x 1	-FC-MT8-FM10	33.6(1.32)	11.0(0.43)	16.2(0.64)	4.0(0.16)	16.0(0.63)	16.0(0.63)
8	M14 x 1.5	-FC-MT8-FM14	35.6(1.40)	13.0(0.51)	16.2(0.64)	6.0(0.24)	16.0(0.63)	19.0(0.75)
8	M20 x 1.5	-FC-MT8-FM20	38.6(1.52)	16.0(0.63)	16.2(0.64)	6.4(0.25)	16.0(0.63)	27.0(1.06)
10	M16 x 1.5	-FC-MT10-FM16	38.1(1.50)	14.0(0.55)	17.2(0.68)	7.9(0.31)	19.0(0.75)	22.0(0.87)
12	M20 x 1.5	-FC-MT12-FM20	44.9(1.77)	16.0(0.63)	22.8(0.90)	9.5(0.37)	22.0(0.87)	27.0(1.06)
14	M10 x 1	-FC-MT14-FM10	42.5(1.67)	11.0(0.43)	24.4(0.96)	4.0(0.16)	25.0(0.98)	24.0(0.94)
14	M20 x 1.5	-FC-MT14-FM20	44.9(1.77)	16.0(0.63)	24.4(0.96)	10.8(0.43)	25.0(0.98)	27.0(1.06)
14	M22 x 1.5	-FC-MT14-FM22	45.9(1.81)	17.0(0.67)	24.4(0.96)	11.1(0.44)	25.0(0.98)	27.0(1.06)
16	M20 x 1.5	-FC-MT16-FM20	44.9(1.77)	16.0(0.63)	24.4(0.96)	10.8(0.43)	26.0(1.02)	27.0(1.06)
20	M20 x 1.5	-FC-MT20-FM20	46.5(1.83)	16.0(0.63)	26.0(1.02)	10.8(0.43)	32.0(1.26)	30.0(1.18)
25	M27 x 2	-FC-MT25-FM27	54.4(2.14)	18.0(0.71)	31.3(1.23)	16.1(0.63)	38.0(1.50)	35.0(1.38)

Bulkhead Unions

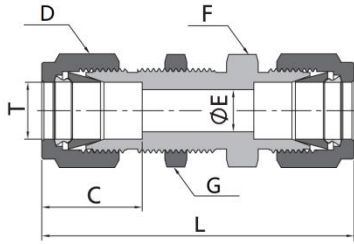

Fractional Tube

T-Tube O.D. (in.)	Basic Ordering Number	Dimension,in(mm)						Panel Hole Size in. (mm)	Max. Panel Thickness in. (mm)
		L	C	E	D	F	G		
1/16	-BU-FT1	1.24(31.5)	0.34(8.6)	0.05(1.3)	0.31(7.9)	0.31(7.9)	0.31(7.9)	0.20(5.2)	0.12(3.0)
1/8	-BU-FT2	2.02(51.3)	0.50(12.7)	0.09(2.3)	0.44(11.1)	0.50(12.7)	0.50(12.7)	0.33(8.3)	0.50(12.7)
3/16	-BU-FT3	2.11(53.6)	0.54(13.7)	0.12(3.0)	0.50(12.7)	0.56(14.3)	0.56(14.3)	0.39(9.9)	0.50(12.7)
1/4	-BU-FT4	2.27(57.7)	0.60(15.2)	0.19(4.8)	0.56(14.3)	0.63(15.9)	0.63(15.9)	0.45(11.5)	0.40(10.2)
5/16	-BU-FT5	2.39(60.7)	0.64(16.3)	0.25(6.4)	0.63(15.9)	0.69(17.5)	0.69(17.5)	0.52(13.1)	0.44(11.2)
3/8	-BU-FT6	2.45(62.2)	0.66(16.8)	0.28(7.1)	0.69(17.5)	0.75(19.1)	0.75(19.1)	0.58(14.7)	0.44(11.2)
1/2	-BU-FT8	2.80(71.1)	0.90(22.9)	0.41(10.4)	0.87(22.2)	0.94(23.8)	0.94(23.8)	0.76(19.4)	0.50(12.7)
5/8	-BU-FT10	2.86(72.6)	0.96(24.4)	0.50(12.7)	1.00(25.4)	1.06(27.0)	1.06(27.0)	0.89(22.6)	0.50(12.7)
3/4	-BU-FT12	3.11(79.0)	0.96(24.4)	0.62(15.7)	1.13(28.6)	1.19(30.2)	1.19(30.2)	1.02(25.8)	0.66(16.8)
7/8	-BU-FT14	3.33(84.6)	1.02(25.9)	0.72(18.3)	1.25(31.8)	1.31(33.3)	1.37(34.9)	1.14(29.0)	0.75(19.1)
1	-BU-FT16	3.77(95.8)	1.23(31.2)	0.88(22.4)	1.50(38.1)	1.63(41.3)	1.63(41.3)	1.33(33.7)	0.75(19.1)
1 1/4	-BU-FT20	4.85(123.2)	1.62(41.1)	1.09(27.8)	1.87(47.6)	1.87(47.6)	1.87(47.6)	1.64(41.7)	0.75(19.1)
1 1/2	-BU-FT24	5.48(139.2)	1.97(50.0)	1.34(34.0)	2.25(57.2)	2.25(57.2)	2.25(57.2)	1.95(49.6)	0.75(19.1)

Metric Tube

T-Tube O.D. (mm)	Basic Ordering Number	Dimension,mm(in)						Panel Hole Size in. (mm)	Max. Panel Thickness in. (mm)
		L	C	E	D	F	G		
3	-BU-MT3	51.3(2.02)	12.9(0.51)	2.4(0.09)	12.0(0.47)	14.0(0.55)	14.0(0.55)	8.3(0.33)	12.7(0.50)
4	-BU-MT4	53.6(2.11)	13.7(0.54)	2.4(0.09)	12.0(0.47)	14.0(0.55)	14.0(0.55)	9.9(0.39)	12.7(0.50)
6	-BU-MT6	57.7(2.27)	15.3(0.60)	4.8(0.19)	14.0(0.55)	16.0(0.63)	16.0(0.63)	11.5(0.45)	10.2(0.40)
8	-BU-MT8	61.0(2.40)	16.2(0.64)	6.4(0.25)	16.0(0.63)	18.0(0.71)	18.0(0.71)	13.1(0.52)	11.2(0.44)
10	-BU-MT10	63.7(2.51)	17.2(0.68)	7.9(0.31)	19.0(0.75)	22.0(0.87)	22.0(0.87)	16.3(0.64)	11.2(0.44)
12	-BU-MT12	71.0(2.80)	22.8(0.90)	9.5(0.37)	22.0(0.87)	24.0(0.94)	24.0(0.94)	19.5(0.77)	12.7(0.50)
14	-BU-MT14	72.5(2.85)	24.4(0.96)	11.1(0.44)	25.0(0.98)	27.0(1.06)	27.0(1.06)	22.5(0.89)	12.7(0.50)
15	-BU-MT15	72.5(2.85)	24.4(0.96)	11.9(0.47)	25.0(0.98)	27.0(1.06)	27.0(1.06)	22.8(0.90)	12.7(0.50)
16	-BU-MT16	72.5(2.85)	24.4(0.96)	12.7(0.50)	25.0(0.98)	27.0(1.06)	27.0(1.06)	22.8(0.90)	12.7(0.50)
18	-BU-MT18	78.9(3.11)	24.4(0.96)	15.1(0.59)	30.0(1.18)	30.0(1.18)	30.0(1.18)	26.0(1.02)	16.8(0.66)
20	-BU-MT20	84.5(3.33)	26.0(1.02)	15.9(0.63)	32.0(1.26)	35.0(1.38)	35.0(1.38)	29.0(1.14)	19.0(0.75)
25	-BU-MT25	96.0(3.78)	31.3(1.23)	21.8(0.86)	38.0(1.50)	41.0(1.61)	41.0(1.61)	34.0(1.34)	19.0(0.75)
30	-BU-MT30	124.0(4.88)	39.6(1.56)	26.2(1.03)	50.0(1.97)	50.0(1.97)	50.0(1.97)	40.5(1.59)	19.0(0.75)
32	-BU-MT32	128.0(5.04)	42.0(1.65)	28.6(1.13)	50.0(1.97)	50.0(1.97)	50.0(1.97)	42.5(1.67)	19.0(0.75)
38	-BU-MT38	145.0(5.71)	49.4(1.94)	33.7(1.33)	60.0(2.36)	60.0(2.36)	60.0(2.36)	50.5(1.99)	19.0(0.75)

Bulkhead Reducing Unions

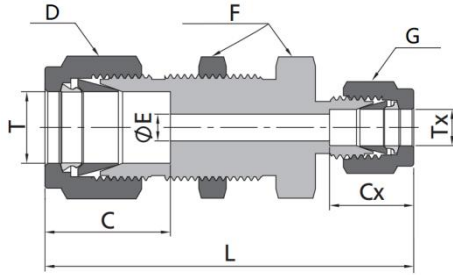

Fractional Tube

T-Tube O.D. (in.)	Tx-Tube O.D. (in.)	Basic Ordering Number	Dimension, in(mm)							Panel Hole Size in. (mm)	Max. Panel Thickness in. (mm)
			L	C	E	D	F	Cx	G		
1/4	1/8	-BRU-FT4-FT2	2.17(55.1)	0.60(15.2)	0.09(2.3)	0.56(14.3)	0.63(15.9)	0.50(12.7)	0.44(11.1)	0.45(11.5)	0.40(10.2)
3/8	1/4	-BRU-FT6-FT4	2.39(60.7)	0.66(16.8)	0.19(4.8)	0.69(17.5)	0.75(19.1)	0.60(15.2)	0.56(14.3)	0.58(14.7)	0.44(11.2)
1/2	1/4	-BRU-FT8-FT4	2.63(66.8)	0.90(22.9)	0.19(4.8)	0.87(22.2)	0.94(23.8)	0.60(15.2)	0.56(14.3)	0.76(19.4)	0.50(12.7)

Metric Tube

T-Tube O.D. (mm)	Tx-Tube O.D. (mm)	Basic Ordering Number	Dimension, mm(in.)							Panel Hole Size in. (mm)	Max. Panel Thickness in. (mm)
			L	C	E	D	F	Cx	G		
6	3	-BRU-MT6-MT3	55.1(2.17)	15.3(0.60)	2.4(0.09)	14.0(0.55)	16.0(0.63)	12.9(0.51)	12.0(0.47)	11.5(0.45)	10.2(0.40)
8	6	-BRU-MT8-MT6	60.1(2.37)	16.2(0.64)	4.8(0.19)	16.0(0.63)	18.0(0.71)	15.3(0.60)	14.0(0.55)	13.1(0.52)	11.2(0.44)
12	8	-BRU-MT12-MT8	67.6(2.66)	22.8(0.90)	6.4(0.25)	22.0(0.87)	24.0(0.94)	16.2(0.64)	16.0(0.63)	19.5(0.77)	12.7(0.50)

Bulkhead Flared Connector

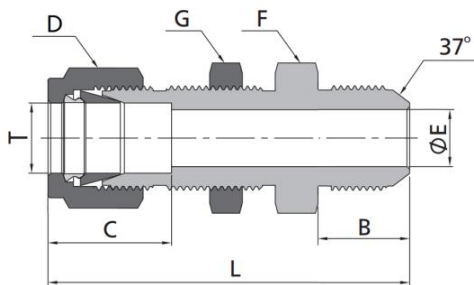

Fractional Tube to 37° Flared

T-Tube O.D. (in.)	Tube Flared Size	Basic Ordering Number	Dimension, in(mm)							Panel Hole Size in. (mm)	Max. Panel Thickness in. (mm)
			L	B	C	E	D	F	G		
1/8	1/8	-BMC-FT2-AN2	1.91(48.5)	0.45(11.4)	0.50(12.7)	0.06(1.5)	0.44(11.1)	0.50(12.7)	0.50(12.7)	0.33(8.3)	0.50(12.7)
1/8	1/4	-BMC-FT2-AN4	2.04(51.8)	0.55(14.0)	0.50(12.7)	0.09(2.3)	0.44(11.1)	0.63(15.9)	0.63(15.9)	0.33(8.3)	0.51(12.7)
3/16	3/16	-BMC-FT3-AN3	1.98(50.3)	0.48(12.2)	0.54(13.7)	0.09(2.3)	0.50(12.7)	0.56(14.3)	0.56(14.3)	0.39(9.9)	0.50(12.7)
1/4	1/4	-BMC-FT4-AN4	2.12(53.8)	0.55(14.0)	0.60(15.2)	0.17(4.3)	0.56(14.3)	0.63(15.9)	0.63(15.9)	0.45(11.5)	0.40(10.2)
5/16	5/16	-BMC-FT5-AN5	2.21(56.1)	0.55(14.0)	0.64(16.2)	0.23(5.8)	0.63(15.9)	0.69(17.5)	0.69(17.5)	0.52(13.1)	0.56(14.3)
3/8	1/4	-BMC-FT6-AN4	2.25(57.2)	0.55(14.0)	0.66(16.8)	0.17(4.3)	0.69(17.5)	0.75(19.1)	0.75(19.1)	0.58(14.7)	0.44(11.2)
3/8	3/8	-BMC-FT6-AN6	2.25(57.2)	0.56(14.2)	0.66(16.8)	0.28(7.1)	0.69(17.5)	0.75(19.1)	0.75(19.1)	0.58(14.7)	0.44(11.2)
1/2	1/2	-BMC-FT8-AN8	2.59(65.8)	0.66(16.8)	0.90(22.8)	0.39(9.9)	0.87(22.2)	0.94(23.8)	0.94(23.8)	0.76(19.4)	0.50(12.7)
5/8	5/8	-BMC-FT10-AN10	2.74(69.6)	0.76(19.3)	0.96(24.4)	0.48(12.3)	1.00(25.4)	1.06(27.0)	1.06(27.0)	0.89(22.6)	0.59(15.1)
3/4	3/4	-BMC-FT12-AN12	3.11(79.0)	0.86(21.8)	0.96(24.4)	0.61(15.5)	1.13(28.6)	1.19(30.2)	1.19(30.2)	1.02(25.8)	0.66(16.8)
1	1	-BMC-FT16-AN16	3.64(92.5)	0.91(23.1)	1.23(31.2)	0.84(21.3)	1.50(38.1)	1.63(41.3)	1.63(41.3)	1.33(33.7)	0.75(19.1)

Bulkhead Male Connector

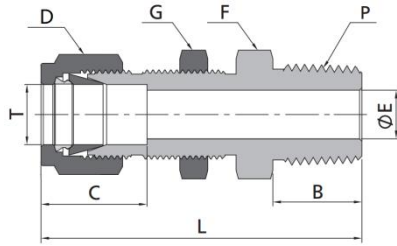

Fractional Tube to NPT Thread

T-Tube O.D. (in.)	P-NPT Size	Basic Ordering Number	Dimension, in.(mm)							Panel Hole Size in. (mm)	Max. Panel Thickness in. (mm)
			L	B	C	E	D	F	G		
1/16	1/16	-BMC-FT1-MN1	1.19(30.2)	0.38(9.7)	0.34(8.6)	0.05(1.3)	0.31(7.9)	0.31(7.9)	0.31(7.9)	0.20(5.2)	0.25(6.4)
1/16	1/8	-BMC-FT1-MN2	1.27(32.3)	0.38(9.7)	0.34(8.6)	0.05(1.3)	0.31(7.9)	0.44(11.1)	0.31(7.9)	0.20(5.2)	0.25(6.4)
1/8	1/8	-BMC-FT2-MN2	1.83(46.5)	0.38(9.7)	0.50(12.7)	0.09(2.3)	0.44(11.1)	0.50(12.7)	0.50(12.7)	0.33(8.3)	0.50(12.7)
3/16	1/8	-BMC-FT3-MN2	1.89(48.0)	0.38(9.7)	0.54(13.7)	0.12(3.0)	0.50(12.7)	0.56(14.3)	0.56(14.3)	0.39(9.9)	0.50(12.7)
1/4	1/8	-BMC-FT4-MN2	1.95(49.5)	0.38(9.7)	0.60(15.2)	0.19(4.8)	0.56(14.3)	0.63(15.9)	0.63(15.9)	0.45(11.5)	0.40(10.2)
1/4	1/4	-BMC-FT4-MN4	2.13(54.1)	0.56(14.2)	0.60(15.2)	0.19(4.8)	0.56(14.3)	0.63(15.9)	0.63(15.9)	0.45(11.5)	0.40(10.2)
1/4	3/8	-BMC-FT4-MN6	2.16(54.9)	0.56(14.2)	0.60(15.2)	0.19(4.8)	0.56(14.3)	0.69(17.5)	0.69(17.5)	0.45(11.5)	0.40(10.2)
1/4	1/2	-BMC-FT4-MN8	2.37(60.3)	0.75(19.1)	0.60(15.2)	0.19(4.8)	0.56(14.3)	0.87(22.2)	0.87(22.2)	0.45(11.5)	0.40(10.2)
5/16	1/8	-BMC-FT5-MN2	2.08(52.8)	0.38(9.7)	0.64(16.3)	0.19(4.8)	0.63(15.9)	0.69(17.5)	0.69(17.5)	0.52(13.1)	0.44(11.2)
5/16	1/4	-BMC-FT5-MN4	2.27(57.7)	0.56(14.2)	0.64(16.3)	0.25(6.4)	0.63(15.9)	0.69(17.5)	0.69(17.5)	0.52(13.1)	0.44(11.2)
3/8	1/8	-BMC-FT6-MN2	2.08(52.9)	0.38(9.7)	0.66(16.8)	0.19(4.8)	0.69(17.5)	0.75(19.1)	0.75(19.1)	0.58(14.7)	0.44(11.2)
3/8	1/4	-BMC-FT6-MN4	2.26(57.4)	0.56(14.2)	0.66(16.8)	0.28(7.1)	0.69(17.5)	0.75(19.1)	0.75(19.1)	0.58(14.7)	0.44(11.2)
3/8	3/8	-BMC-FT6-MN6	2.26(57.4)	0.56(14.2)	0.66(16.8)	0.28(7.1)	0.69(17.5)	0.75(19.1)	0.75(19.1)	0.58(14.7)	0.44(11.2)
3/8	1/2	-BMC-FT6-MN8	2.51(63.8)	0.75(19.1)	0.66(16.8)	0.28(7.1)	0.69(17.5)	0.87(22.2)	0.87(22.2)	0.58(14.7)	0.44(11.2)
1/2	1/8	-BMC-FT8-MN2	2.31(58.7)	0.38(9.7)	0.90(22.9)	0.19(4.8)	0.87(22.2)	0.94(23.8)	0.94(23.8)	0.76(19.4)	0.50(12.7)
1/2	1/4	-BMC-FT8-MN4	2.49(63.2)	0.56(14.2)	0.90(22.9)	0.28(7.1)	0.87(22.2)	0.94(23.8)	0.94(23.8)	0.76(19.4)	0.50(12.7)
1/2	3/8	-BMC-FT8-MN6	2.49(63.2)	0.56(14.2)	0.90(22.9)	0.38(9.7)	0.87(22.0)	0.94(23.8)	0.94(23.8)	0.76(19.4)	0.50(12.7)
1/2	1/2	-BMC-FT8-MN8	2.71(68.8)	0.75(19.1)	0.90(22.9)	0.41(10.4)	0.87(22.0)	0.94(23.8)	0.94(23.8)	0.76(19.4)	0.50(12.7)
5/8	3/8	-BMC-FT10-MN6	2.63(66.7)	0.56(14.2)	0.96(24.4)	0.38(9.7)	1.00(25.4)	1.06(27.0)	1.06(27.0)	0.89(22.6)	0.59(15.1)
5/8	1/2	-BMC-FT10-MN8	2.81(71.5)	0.75(19.1)	0.96(24.4)	0.47(11.9)	1.00(25.4)	1.06(27.0)	1.06(27.0)	0.89(22.6)	0.59(15.1)
3/4	1/2	-BMC-FT12-MN8	3.00(76.2)	0.75(19.1)	0.96(24.4)	0.47(11.9)	1.13(28.6)	1.19(30.2)	1.19(30.2)	1.02(25.8)	0.66(16.8)
3/4	3/4	-BMC-FT12-MN12	3.00(76.2)	0.75(19.1)	0.96(24.4)	0.62(15.7)	1.13(28.6)	1.19(30.2)	1.19(30.2)	1.02(25.8)	0.66(16.8)
7/8	3/4	-BMC-FT14-MN12	3.31(84.1)	0.75(19.1)	1.02(25.9)	0.62(15.7)	1.25(31.8)	1.31(33.3)	1.31(33.3)	1.14(29.0)	0.75(19.1)
1	3/4	-BMC-FT16-MN12	3.48(88.4)	0.75(19.1)	1.23(31.2)	0.62(15.7)	1.50(38.1)	1.63(41.3)	1.63(41.3)	1.33(33.7)	0.75(19.1)
1	1	-BMC-FT16-MN16	3.67(93.2)	0.94(23.9)	1.23(31.2)	0.88(22.4)	1.50(38.1)	1.63(41.3)	1.63(41.3)	1.33(33.7)	0.75(19.1)

Metric Tube to NPT Thread

T-Tube O.D. (mm.)	P-NPT Size	Basic Ordering Number	Dimension, mm. (in.)							Panel Hole Size in. (mm)	Max. Panel Thickness in. (mm)
			L	B	C	E	D	F	G		
6	1/8	-BMC-MT6-NS2	49.6(1.95)	9.7(0.38)	15.3(0.60)	4.8(0.19)	14.0(0.55)	16.0(0.63)	16.0(0.63)	11.5(0.45)	10.2(0.40)
6	1/4	-BMC-MT6-NS4	53.6(2.11)	14.2(0.56)	15.3(0.60)	4.8(0.19)	14.0(0.55)	16.0(0.63)	16.0(0.63)	11.5(0.45)	10.2(0.40)
8	1/8	-BMC-MT8-NS2	52.3(2.06)	9.7(0.38)	16.2(0.64)	4.8(0.19)	16.0(0.63)	18.0(0.71)	18.0(0.71)	13.1(0.52)	11.2(0.44)
8	1/4	-BMC-MT8-NS4	57.5(2.26)	14.2(0.56)	16.2(0.64)	6.4(0.25)	16.0(0.63)	18.0(0.71)	18.0(0.71)	13.1(0.52)	11.2(0.44)
10	1/4	-BMC-MT10-NS4	58.4(2.30)	14.2(0.56)	17.2(0.68)	7.9(0.31)	19.0(0.75)	22.0(0.87)	22.0(0.87)	16.3(0.64)	11.2(0.44)
10	3/8	-BMC-MT10-NS6	58.4(2.30)	14.2(0.56)	17.2(0.68)	7.9(0.31)	19.0(0.75)	22.0(0.87)	22.0(0.87)	16.3(0.64)	11.2(0.44)
10	1/2	-BMC-MT10-NS8	63.1(2.48)	19.1(0.75)	17.2(0.68)	7.9(0.31)	19.0(0.75)	22.0(0.87)	22.0(0.87)	16.3(0.64)	11.2(0.44)
12	1/4	-BMC-MT12-NS4	63.9(2.52)	14.2(0.56)	22.8(0.90)	7.9(0.31)	22.0(0.87)	24.0(0.94)	24.0(0.94)	19.5(0.77)	12.7(0.50)
12	3/8	-BMC-MT12-NS6	63.9(2.52)	14.2(0.56)	22.8(0.90)	9.5(0.37)	22.0(0.87)	24.0(0.94)	24.0(0.94)	19.5(0.77)	12.7(0.50)
12	1/2	-BMC-MT12-NS8	68.8(2.71)	19.1(0.75)	22.8(0.90)	9.5(0.37)	22.0(0.87)	24.0(0.94)	24.0(0.94)	19.5(0.77)	12.7(0.50)

Bulkhead Female Connector

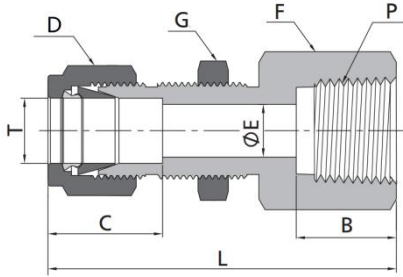

Fractional Tube to NPT Thread

T-Tube O.D. (in.)	P-NPT Size	Basic Ordering Number	Dimension, in.(mm)							Panel Hole Size in. (mm)	Max. Panel Thickness in. (mm)
			L	B	C	E	D	F	G		
1/16	1/16	-BFC-FT1-FN1	1.03(26.2)	0.39(9.9)	0.34(8.6)	0.05(1.3)	0.31(7.9)	0.44(11.1)	0.31(7.9)	0.20(5.2)	0.13(3.2)
1/16	1/8	-BFC-FT1-FN2	1.06(26.9)	0.41(10.4)	0.34(8.6)	0.05(1.3)	0.31(7.9)	0.56(14.3)	0.31(7.9)	0.20(5.2)	0.13(3.2)
1/8	1/8	-BFC-FT2-FN2	1.76(44.7)	0.41(10.4)	0.50(12.7)	0.09(2.3)	0.44(11.1)	0.56(14.3)	0.50(12.7)	0.33(8.3)	0.50(12.7)
1/8	1/4	-BFC-FT2-FN4	1.95(49.6)	0.59(15.0)	0.50(12.7)	0.09(2.3)	0.44(11.1)	0.75(19.1)	0.50(12.7)	0.33(8.3)	0.50(12.7)
3/16	1/8	-BFC-FT3-FN2	1.79(45.5)	0.41(10.4)	0.54(13.7)	0.12(3.0)	0.50(12.7)	0.56(14.3)	0.56(14.3)	0.39(9.9)	0.50(12.7)
1/4	1/8	-BFC-FT4-FN2	1.85(47.0)	0.41(10.4)	0.60(15.2)	0.19(4.8)	0.56(14.3)	0.63(15.9)	0.63(15.9)	0.45(11.5)	0.40(10.2)
1/4	1/4	-BFC-FT4-FN4	2.04(51.8)	0.59(15.0)	0.60(15.2)	0.19(4.8)	0.56(14.3)	0.75(19.1)	0.63(15.9)	0.45(11.5)	0.40(10.2)
1/4	3/8	-BFC-FT4-FN6	2.10(53.3)	0.59(15.0)	0.60(15.2)	0.19(4.8)	0.56(14.3)	0.87(22.2)	0.63(15.9)	0.45(11.5)	0.40(10.2)
1/4	1/2	-BFC-FT4-FN8	2.29(58.2)	0.78(19.8)	0.60(15.2)	0.19(4.8)	0.56(14.3)	1.06(27.0)	0.63(15.9)	0.45(11.5)	0.40(10.2)
5/16	1/8	-BFC-FT5-FN2	1.96(49.8)	0.41(10.4)	0.64(16.3)	0.25(6.4)	0.63(15.9)	0.56(14.3)	0.69(17.5)	0.52(13.1)	0.44(11.2)
5/16	1/4	-BFC-FT5-FN4	2.38(60.5)	0.59(15.0)	0.64(16.3)	0.25(6.4)	0.63(15.9)	0.75(19.1)	0.69(17.5)	0.52(13.1)	0.44(11.2)
3/8	1/8	-BFC-FT6-FN2	1.98(50.3)	0.41(10.4)	0.66(16.8)	0.28(7.1)	0.69(17.5)	0.63(15.9)	0.75(19.1)	0.58(14.7)	0.44(11.2)
3/8	1/4	-BFC-FT6-FN4	2.17(55.1)	0.59(15.0)	0.66(16.8)	0.28(7.1)	0.69(17.5)	0.75(19.1)	0.75(19.1)	0.58(14.7)	0.44(11.2)
3/8	3/8	-BFC-FT6-FN6	2.23(56.6)	0.59(15.0)	0.66(16.8)	0.28(7.1)	0.69(17.5)	0.87(22.2)	0.75(19.1)	0.58(14.7)	0.44(11.2)
3/8	1/2	-BFC-FT6-FN8	2.42(61.5)	0.78(19.8)	0.66(16.8)	0.28(7.1)	0.69(17.5)	1.06(27.0)	0.75(19.1)	0.58(14.7)	0.44(11.2)
3/8	3/4	-BFC-FT6-FN12	2.57(65.3)	0.81(20.6)	0.66(16.8)	0.28(7.1)	0.69(17.5)	1.31(33.3)	0.75(19.1)	0.58(14.7)	0.44(11.2)
1/2	1/4	-BFC-FT8-FN4	2.37(60.2)	0.59(15.0)	0.90(22.9)	0.41(10.4)	0.87(22.2)	0.94(23.8)	0.94(23.8)	0.76(19.4)	0.50(12.7)
1/2	3/8	-BFC-FT8-FN6	2.43(61.7)	0.59(15.0)	0.90(22.9)	0.41(10.4)	0.87(22.2)	0.94(23.8)	0.94(23.8)	0.76(19.4)	0.50(12.7)
1/2	1/2	-BFC-FT8-FN8	2.62(66.5)	0.78(19.8)	0.90(22.9)	0.41(10.4)	0.87(22.2)	1.06(27.0)	0.94(23.8)	0.76(19.4)	0.50(12.7)
1/2	3/4	-BFC-FT8-FN12	2.68(68.1)	0.81(20.6)	0.90(22.9)	0.41(10.4)	0.87(22.2)	1.31(33.3)	0.94(23.8)	0.76(19.4)	0.50(12.7)
5/8	3/8	-BFC-FT10-FN6	2.46(62.5)	0.59(15.0)	0.96(24.4)	0.50(12.7)	1.00(25.4)	0.94(23.8)	1.06(27.0)	0.89(22.6)	0.59(15.1)
5/8	1/2	-BFC-FT10-FN8	2.65(67.3)	0.78(19.8)	0.96(24.4)	0.50(12.7)	1.00(25.4)	1.06(27.0)	1.06(27.0)	0.89(22.6)	0.59(15.1)
3/4	1/2	-BFC-FT12-FN8	2.84(72.2)	0.78(19.8)	0.96(24.4)	0.62(15.7)	1.13(28.6)	1.06(27.0)	1.19(30.2)	1.02(25.8)	0.78(19.8)
3/4	3/4	-BFC-FT12-FN12	2.90(73.7)	0.81(20.6)	0.96(24.4)	0.62(15.7)	1.13(28.6)	1.31(33.3)	1.19(30.2)	1.02(25.8)	0.78(19.8)
7/8	3/4	-BFC-FT14-FN12	3.18(80.8)	0.81(20.6)	1.02(25.9)	0.72(18.3)	1.25(31.8)	1.31(33.3)	1.31(33.3)	1.14(29.0)	0.94(23.8)
1	3/4	-BFC-FT16-FN12	3.33(84.7)	0.81(20.6)	1.23(31.2)	0.88(22.4)	1.50(38.1)	1.63(41.3)	1.63(41.3)	1.33(33.7)	0.94(23.8)
1	1	-BFC-FT16-FN16	3.68(93.5)	1.00(25.4)	1.23(31.2)	0.88(22.4)	1.50(38.1)	1.63(41.3)	1.63(41.3)	1.33(33.7)	0.94(23.8)

Metric Tube to NPT Thread

T-Tube O.D. (mm.)	P-NPT Size	Basic Ordering Number	Dimension, mm. (in.)							Panel Hole Size in. (mm)	Max. Panel Thickness in. (mm)
			L	B	C	E	D	F	G		
6	1/8	-BFC-MT6-FN2	47.2(1.86)	10.4(0.41)	15.3(0.60)	4.8(0.19)	14.0(0.55)	16.0(0.63)	16.0(0.63)	11.5(0.45)	10.2(0.40)
6	1/4	-BFC-MT6-FN4	51.8(2.04)	15.0(0.59)	15.3(0.60)	4.8(0.19)	14.0(0.55)	19.0(0.75)	16.0(0.63)	11.5(0.45)	10.2(0.40)
8	1/8	-BFC-MT8-FN2	49.6(1.95)	10.4(0.41)	16.2(0.64)	4.8(0.19)	16.0(0.63)	18.0(0.71)	18.0(0.71)	13.1(0.52)	11.2(0.44)
10	1/4	-BFC-MT10-FN4	55.2(2.17)	15.0(0.59)	17.2(0.68)	7.9(0.31)	19.0(0.75)	22.0(0.87)	22.0(0.87)	16.3(0.64)	11.2(0.44)
12	3/8	-BFC-MT12-FN6	60.9(2.40)	15.0(0.59)	22.8(0.90)	9.5(0.37)	22.0(0.87)	24.0(0.94)	24.0(0.94)	19.5(0.77)	12.7(0.50)
12	1/2	-BFC-MT12-FN8	66.5(2.62)	19.8(0.78)	22.8(0.90)	9.5(0.37)	22.0(0.87)	24.0(0.94)	24.0(0.94)	19.5(0.77)	12.7(0.50)

Union Elbows

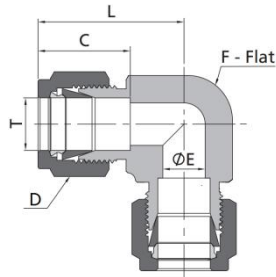

Fractional Tube

T-Tube O.D. (in.)	Basic Ordering Number	Dimension, in(mm)				
		L	C	D	F	E
1/16	-UE-FT1	0.70(17.8)	0.34(8.6)	0.31(7.9)	0.37(9.5)	0.05(1.3)
1/8	-UE-FT2	0.88(22.4)	0.50(12.7)	0.44(11.1)	0.37(9.5)	0.09(2.3)
3/16	-UE-FT3	1.00(25.4)	0.54(13.7)	0.50(12.7)	0.50(12.7)	0.12(3.0)
1/4	-UE-FT4	1.06(26.9)	0.60(15.2)	0.56(14.3)	0.50(12.7)	0.19(4.8)
5/16	-UE-FT5	1.13(28.7)	0.64(16.3)	0.63(15.9)	0.56(14.3)	0.25(6.4)
3/8	-UE-FT6	1.20(30.5)	0.66(16.8)	0.69(17.5)	0.63(15.9)	0.28(7.1)
1/2	-UE-FT8	1.42(36.1)	0.90(22.9)	0.87(22.2)	0.81(20.6)	0.41(10.4)
5/8	-UE-FT10	1.50(38.1)	0.96(24.4)	1.00(25.4)	0.94(23.8)	0.5(12.7)
3/4	-UE-FT12	1.57(39.9)	0.96(24.4)	1.13(28.6)	1.06(27.0)	0.62(15.7)
7/8	-UE-FT14	1.76(44.7)	1.02(25.9)	1.25(31.8)	1.37(34.9)	0.72(18.3)
1	-UE-FT16	1.93(49.0)	1.23(31.2)	1.50(38.1)	1.37(34.9)	0.88(22.4)
1 1/8	-UE-FT18	2.17(55.1)	1.23(31.2)	1.63(41.3)	1.69(42.9)	0.97(24.6)
1 1/4	-UE-FT20	2.62(66.5)	1.62(41.1)	1.87(47.6)	1.69(42.9)	1.09(27.7)
1 1/2	-UE-FT24	3.07(78.0)	1.97(50.0)	2.25(57.2)	2.00(50.8)	1.34(34.0)

Metric Tube

T-Tube O.D. (mm)	Basic Ordering Number	Dimension, mm(in.)				
		L	C	D	F	E
3	-UE-MT3	22.3(0.88)	12.9(0.51)	12.0(0.47)	9.5(0.37)	2.4(0.09)
4	-UE-MT4	25.4(1.00)	13.7(0.54)	12.0(0.47)	12.7(0.50)	2.4(0.09)
6	-UE-MT6	27.0(1.06)	15.3(0.60)	14.0(0.55)	12.7(0.50)	4.8(0.19)
8	-UE-MT8	28.8(1.13)	16.2(0.64)	16.0(0.63)	14.3(0.56)	6.4(0.25)
10	-UE-MT10	31.5(1.24)	17.2(0.68)	19.0(0.75)	17.5(0.69)	7.9(0.31)
12	-UE-MT12	36.0(1.42)	22.8(0.90)	22.0(0.87)	20.6(0.81)	9.5(0.37)
14	-UE-MT14	38.0(1.50)	24.4(0.96)	25.0(0.98)	23.8(0.94)	11.0(0.43)
15	-UE-MT15	38.8(1.53)	24.4(0.96)	25.0(0.98)	23.8(0.94)	11.9(0.47)
16	-UE-MT16	38.0(1.50)	24.4(0.96)	25.0(0.98)	23.8(0.94)	12.7(0.50)
18	-UE-MT18	39.8(1.57)	24.4(0.96)	30.0(1.18)	27.0(1.06)	15.1(0.59)
20	-UE-MT20	44.6(1.76)	26.0(1.02)	32.0(1.26)	34.9(1.37)	15.9(0.63)
22	-UE-MT22	44.6(1.76)	26.0(1.02)	32.0(1.26)	34.9(1.37)	18.3(0.72)
25	-UE-MT25	49.1(1.93)	31.3(1.23)	38.0(1.5)	34.9(1.37)	21.8(0.86)
28	-UE-MT28	64.0(2.52)	36.6(1.44)	46.0(1.81)	42.9(1.69)	21.8(0.86)
30	-UE-MT30	69.9(2.75)	39.6(1.56)	50.0(1.97)	42.9(1.69)	26.2(1.03)
32	-UE-MT32	72.3(2.85)	42.0(1.65)	50.0(1.97)	42.9(1.69)	28.6(1.13)
38	-UE-MT38	84.0(3.31)	49.4(1.94)	60.0(2.36)	50.8(2.00)	33.7(1.33)

Union Reducing Elbows

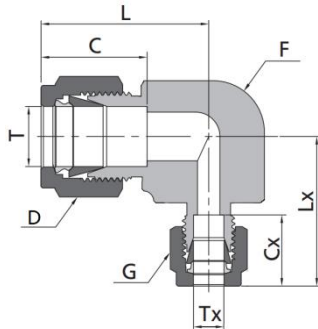

Fractional Tube									
T-Tube O.D. (in.)	Tx-Tube O.D. (in.)	Basic Ordering Number	Dimension, in(mm)						
			L	C	D	F	Cx	G	Lx
3/16	1/8	-URE-FT3-FT2	1.00(25.4)	0.54(13.7)	0.50(12.7)	0.50(12.7)	0.50(12.7)	0.44(11.1)	0.97(24.7)
1/4	1/8	-URE-FT4-FT2	1.06(26.9)	0.60(15.2)	0.56(14.3)	0.50(12.7)	0.50(12.7)	0.44(11.1)	1.00(25.4)
5/16	1/8	-URE-FT5-FT2	1.17(29.7)	0.64(16.3)	0.63(15.9)	0.56(14.3)	0.50(12.7)	0.44(11.1)	1.04(26.4)
5/16	1/4	-URE-FT5-FT4	1.17(29.7)	0.64(16.3)	0.63(15.9)	0.56(14.3)	0.60(15.2)	0.56(14.3)	1.14(29.0)
3/8	1/8	-URE-FT6-FT2	1.20(30.5)	0.66(16.8)	0.69(17.5)	0.63(15.9)	0.50(12.7)	0.44(11.1)	1.04(26.4)
3/8	1/4	-URE-FT6-FT4	1.20(30.5)	0.66(16.8)	0.69(17.5)	0.63(15.9)	0.60(15.2)	0.56(14.3)	1.14(29.0)
3/8	5/16	-URE-FT6-FT5	1.20(30.5)	0.66(16.8)	0.69(17.5)	0.63(15.9)	0.64(16.3)	0.63(15.9)	1.17(29.7)
1/2	1/4	-URE-FT8-FT4	1.42(36.1)	0.90(22.9)	0.87(22.2)	0.81(20.6)	0.60(15.2)	0.56(14.3)	1.27(32.2)
1/2	5/16	-URE-FT8-FT5	1.42(36.1)	0.90(22.9)	0.87(22.2)	0.81(20.6)	0.64(16.3)	0.63(15.9)	1.28(32.5)
1/2	3/8	-URE-FT8-FT6	1.42(36.1)	0.90(22.9)	0.87(22.2)	0.81(20.6)	0.66(16.8)	0.69(17.5)	1.32(33.6)
5/8	3/8	-URE-FT10-FT6	1.50(38.1)	0.96(24.4)	1.00(25.4)	0.94(23.8)	0.66(16.8)	0.69(17.5)	1.40(35.6)
5/8	1/2	-URE-FT10-FT8	1.50(38.1)	0.96(24.4)	1.00(25.4)	0.94(23.8)	0.90(22.9)	0.87(22.2)	1.50(38.1)
3/4	1/4	-URE-FT12-FT4	1.57(39.9)	0.96(24.4)	1.13(28.6)	1.06(27.0)	0.60(15.2)	0.56(14.3)	1.41(35.9)
3/4	3/8	-URE-FT12-FT6	1.57(39.9)	0.96(24.4)	1.13(28.6)	1.06(27.0)	0.66(16.8)	0.69(17.5)	1.47(37.4)
3/4	1/2	-URE-FT12-FT8	1.57(39.9)	0.96(24.4)	1.13(28.6)	1.06(27.0)	0.90(22.9)	0.87(22.2)	1.57(39.9)
7/8	1/4	-URE-FT14-FT4	1.76(44.7)	1.02(25.9)	1.25(31.8)	1.37(34.9)	0.60(15.2)	0.56(14.3)	1.60(40.7)
1	1/2	-URE-FT16-FT8	1.93(49.0)	1.23(31.2)	1.50(38.1)	1.37(34.9)	0.90(22.9)	0.87(22.2)	1.75(44.4)
1	3/4	-URE-FT16-FT12	1.93(49.0)	1.23(31.2)	1.50(38.1)	1.37(34.9)	0.96(24.4)	1.13(28.6)	1.75(44.4)

Metric Tube									
T-Tube O.D. (mm)	Tx-Tube O.D. (mm)	Basic Ordering Number	Dimension, mm(in.)						
			L	C	D	F	Cx	G	Lx
8	6	-URE-MT8-MT6	28.8(1.13)	16.2(0.64)	16.0(0.63)	14.3(0.56)	15.3(0.60)	14.0(0.55)	27.9(1.10)
10	8	-URE-MT10-MT8	31.5(1.24)	17.2(0.68)	19.0(0.75)	17.5(0.69)	16.2(0.64)	16.0(0.63)	30.5(1.20)
12	8	-URE-MT12-MT8	36.0(1.42)	22.8(0.90)	22.0(0.87)	20.6(0.81)	16.2(0.64)	16.0(0.63)	32.6(1.28)
14	8	-URE-MT14-MT8	38.8(1.53)	24.4(0.96)	25.0(0.98)	23.8(0.94)	16.2(0.64)	16.0(0.63)	35.4(1.39)
14	10	-URE-MT14-MT10	38.8(1.53)	24.4(0.96)	25.0(0.98)	23.8(0.94)	17.2(0.68)	19.0(0.75)	36.4(1.43)
18	12	-URE-MT18-MT12	39.9(1.57)	24.4(0.96)	30.0(1.18)	27.0(1.06)	22.8(0.90)	22.0(0.87)	38.8(1.53)
22	12	-URE-MT22-MT12	44.7(1.76)	26.0(1.02)	32.0(1.26)	34.9(1.37)	22.8(0.90)	22.0(0.87)	39.8(1.57)
25	18	-URE-MT25-MT20	49.0(1.93)	31.2(1.23)	38.0(1.5)	34.9(1.37)	24.4(0.96)	30.0(1.18)	44.4(1.75)

Male Elbows

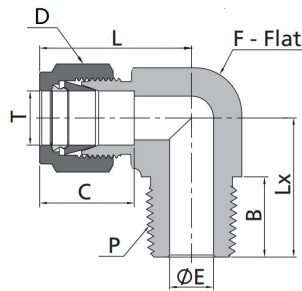

Fractional Tube to NPT Thread

T-Tube O.D.(in.)	P-NPT SIZE	Basic Ordering Number	Dimension,in(mm)						
			L	C	D	F	E	B	Lx
1/16	1/16	-ME-FT1-MN1	0.75(19.1)	0.34(8.6)	0.31(7.9)	0.44(11.1)	0.05(1.3)	0.38(9.7)	0.70(17.8)
1/16	1/8	-ME-FT1-MN2	0.75(19.1)	0.34(8.6)	0.31(7.9)	0.44(11.1)	0.05(1.3)	0.38(9.7)	0.70(17.8)
1/8	1/16	-ME-FT2-MN1	0.93(23.6)	0.50(12.7)	0.44(11.1)	0.44(11.1)	0.09(2.4)	0.38(9.7)	0.70(17.8)
1/8	1/8	-ME-FT2-MN2	0.93(23.6)	0.50(12.7)	0.44(11.1)	0.44(11.1)	0.09(2.4)	0.38(9.7)	0.70(17.8)
1/8	1/4	-ME-FT2-MN4	0.97(24.6)	0.50(12.7)	0.44(11.1)	0.50(12.7)	0.09(2.4)	0.56(14.2)	0.92(23.4)
3/16	1/8	-ME-FT3-MN2	1.00(25.4)	0.54(13.7)	0.50(12.7)	0.50(12.7)	0.12(3.0)	0.38(9.7)	0.74(18.8)
3/16	1/4	-ME-FT3-MN4	1.00(25.4)	0.54(13.7)	0.50(12.7)	0.50(12.7)	0.12(3.0)	0.56(14.2)	0.92(23.4)
1/4	1/8	-ME-FT4-MN2	1.06(26.9)	0.60(15.2)	0.56(14.3)	0.50(12.7)	0.19(4.8)	0.38(9.7)	0.74(18.8)
1/4	1/4	-ME-FT4-MN4	1.06(26.9)	0.60(15.2)	0.56(14.3)	0.50(12.7)	0.19(4.8)	0.56(14.2)	0.92(23.4)
1/4	3/8	-ME-FT4-MN6	1.17(29.7)	0.60(15.2)	0.56(14.3)	0.69(17.5)	0.19(4.8)	0.56(14.2)	1.03(26.2)
5/16	1/4	-ME-FT5-MN4	1.13(28.7)	0.64(16.3)	0.63(15.9)	0.56(14.3)	0.25(6.4)	0.56(14.2)	0.96(24.4)
5/16	3/8	-ME-FT5-MN6	1.20(30.5)	0.64(16.3)	0.63(15.9)	0.69(17.5)	0.25(6.4)	0.56(14.2)	1.03(26.2)
3/8	1/4	-ME-FT6-MN4	1.20(30.5)	0.66(16.8)	0.69(17.5)	0.63(15.9)	0.28(7.1)	0.56(14.2)	1.00(25.4)
3/8	3/8	-ME-FT6-MN6	1.23(31.2)	0.66(16.8)	0.69(17.5)	0.69(17.5)	0.28(7.1)	0.56(14.2)	1.03(26.2)
3/8	1/2	-ME-FT6-MN8	1.31(33.3)	0.66(16.8)	0.69(17.5)	0.81(20.6)	0.28(7.1)	0.75(19.1)	1.30(33.0)
1/2	1/4	-ME-FT8-MN4	1.42(36.1)	0.90(22.9)	0.87(22.2)	0.81(20.6)	0.28(7.1)	0.56(14.2)	1.11(28.2)
1/2	3/8	-ME-FT8-MN6	1.42(36.1)	0.90(22.9)	0.87(22.2)	0.81(20.6)	0.38(9.7)	0.56(14.2)	1.11(28.2)
1/2	1/2	-ME-FT8-MN8	1.42(36.1)	0.90(22.9)	0.87(22.2)	0.81(20.6)	0.41(10.4)	0.75(19.1)	1.30(33.0)
1/2	3/4	-ME-FT8-MN12	1.57(39.9)	0.90(22.9)	0.87(22.2)	1.06(27.0)	0.41(10.4)	0.75(19.1)	1.45(36.8)
5/8	3/8	-ME-FT10-MN6	1.50(38.1)	0.96(24.4)	1.00(25.4)	0.94(23.8)	0.38(9.7)	0.56(14.2)	1.19(30.2)
5/8	1/2	-ME-FT10-MN8	1.50(38.1)	0.96(24.4)	1.00(25.4)	0.94(23.8)	0.47(11.9)	0.75(19.1)	1.38(35.1)
5/8	3/4	-ME-FT10-MN12	1.57(39.9)	0.96(24.4)	1.00(25.4)	1.06(27.0)	0.50(12.7)	0.75(19.1)	1.45(36.8)
3/4	1/2	-ME-FT12-MN8	1.57(39.9)	0.96(24.4)	1.13(28.6)	1.06(27.0)	0.47(11.9)	0.75(19.1)	1.45(36.8)
3/4	3/4	-ME-FT12-MN12	1.57(39.9)	0.96(24.4)	1.13(28.6)	1.06(27.0)	0.62(15.7)	0.75(19.1)	1.45(36.8)
7/8	3/4	-ME-FT14-MN12	1.76(44.7)	1.02(25.9)	1.25(31.8)	1.37(34.9)	0.62(15.7)	0.75(19.1)	1.64(41.7)
1	3/4	-ME-FT16-MN12	1.93(49.0)	1.23(31.2)	1.50(38.1)	1.37(34.9)	0.62(15.7)	0.75(19.1)	1.64(41.7)
1	1	-ME-FT16-MN16	1.93(49.0)	1.23(31.2)	1.50(38.1)	1.37(34.9)	0.88(22.4)	0.94(23.9)	1.83(46.5)
1 1/4	1 1/4	-ME-FT20-MN20	2.62(66.5)	1.62(41.1)	1.87(47.6)	1.69(42.9)	1.09(27.7)	0.94(23.9)	2.06(52.4)
1 1/2	1 1/2	-ME-FT24-MN24	3.07(78.0)	1.97(50.0)	2.25(57.2)	2.00(50.8)	1.34(34.0)	1.03(26.2)	2.38(60.5)

Fractional Tube to RT Thread

T-Tube O.D.(in.)	P-RT SIZE	Basic Ordering Number	Dimension,in(mm)						
			L	C	D	F	E	B	Lx
1/8	1/8	-ME-FT2-RT2	0.93(23.6)	0.50(12.7)	0.44(11.1)	0.44(11.1)	0.09(2.4)	0.38(9.7)	0.70(17.8)
1/8	1/4	-ME-FT2-RT4	0.97(24.6)	0.50(12.7)	0.44(11.1)	0.50(12.7)	0.09(2.4)	0.56(14.2)	0.92(23.4)
1/4	1/4	ME-FT4-RT4	1.06(26.9)	0.60(15.2)	0.56(14.3)	0.50(12.7)	0.19(4.8)	0.56(14.2)	0.92(23.4)
1/4	3/8	--ME-FT4-RT6	1.17(29.7)	0.60(15.2)	0.56(14.3)	0.69(17.5)	0.19(4.8)	0.56(14.2)	1.03(26.2)
5/16	1/4	ME-FT5-RT4	1.13(28.7)	0.64(16.3)	0.63(15.9)	0.56(14.3)	0.25(6.4)	0.56(14.2)	0.96(24.4)
3/8	1/4	-ME-FT6-RT4	1.20(30.5)	0.66(16.8)	0.69(17.5)	0.63(15.9)	0.28(7.1)	0.56(14.2)	1.00(25.4)
3/8	3/8	-ME-FT6-RT6	1.23(31.2)	0.66(16.8)	0.69(17.5)	0.69(17.5)	0.28(7.1)	0.56(14.2)	1.03(26.2)
1/2	3/8	-ME-FT8-RT6	1.42(36.1)	0.90(22.9)	0.87(22.2)	0.81(20.6)	0.38(9.7)	0.56(14.2)	1.10(27.9)
1/2	1/2	-ME-FT8-RT8	1.42(36.1)	0.90(22.9)	0.87(22.2)	0.81(20.6)	0.41(10.4)	0.75(19.1)	1.30(33.0)
3/4	1/2	-ME-FT12-RT8	1.57(39.9)	0.96(24.4)	1.13(28.6)	1.06(27.0)	0.47(11.9)	0.75(19.1)	1.45(36.8)
1	1	-ME-FT16-RT16	1.93(49.0)	1.23(31.2)	1.50(38.1)	1.37(34.9)	0.88(22.4)	0.94(23.9)	1.83(46.5)

Male Elbows

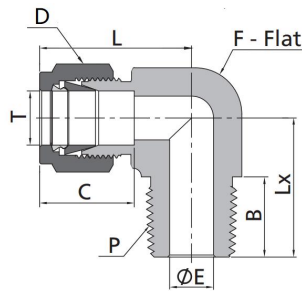

Metric Tube to NPT Thread

T-Tube O.D.(mm)	P-RT SIZE	Basic Ordering Number	Dimension,mm(in)						
			L	C	D	F	E	B	Lx
3	1/8	-ME-MT3-MN2	23.6(0.93)	12.9(0.51)	12.0(0.47)	11.1(0.44)	2.4(0.09)	9.7(0.38)	17.8(0.70)
3	1/4	-ME-MT3-MN4	24.6(0.97)	12.9(0.51)	12.0(0.47)	12.7(0.50)	2.4(0.09)	14.2(0.56)	23.4(0.92)
4	1/8	-ME-MT4-MN2	25.4(1.00)	13.7(0.54)	12.0(0.47)	12.7(0.50)	2.4(0.09)	9.7(0.38)	18.8(0.74)
4	1/4	-ME-MT4-MN4	25.4(1.00)	13.7(0.54)	12.0(0.47)	12.7(0.50)	2.4(0.09)	14.2(0.56)	23.4(0.92)
6	1/8	-ME-MT6-MN2	27.0(1.06)	15.3(0.60)	14.0(0.55)	12.7(0.50)	4.8(0.19)	9.7(0.38)	18.8(0.74)
6	1/4	-ME-MT6-MN4	27.0(1.06)	15.3(0.60)	14.0(0.55)	12.7(0.50)	4.8(0.19)	14.2(0.56)	23.4(0.92)
8	1/4	-ME-MT8-MN4	28.8(1.13)	16.2(0.64)	16.0(0.63)	14.3(0.56)	6.4(0.25)	14.2(0.56)	24.4(0.96)
8	3/8	-ME-MT8-MN6	30.6(1.20)	16.2(0.64)	16.0(0.63)	17.5(0.69)	6.4(0.25)	14.2(0.56)	26.2(1.03)
10	1/4	-ME-MT10-MN4	31.5(1.24)	17.2(0.68)	19.0(0.75)	17.5(0.69)	7.1(0.28)	14.2(0.56)	26.2(1.03)
10	3/8	-ME-MT10-MN6	31.5(1.24)	17.2(0.68)	19.0(0.75)	17.5(0.69)	7.9(0.31)	14.2(0.56)	26.2(1.03)
10	1/2	-ME-MT10-MN8	33.5(1.32)	17.2(0.68)	19.0(0.75)	20.6(0.81)	7.9(0.31)	19.1(0.75)	33.0(1.30)
12	3/8	-ME-MT12-MN6	36.0(1.42)	22.8(0.90)	22.0(0.87)	20.6(0.81)	9.5(0.37)	14.2(0.56)	28.2(1.11)
12	1/2	-ME-MT12-MN8	36.0(1.42)	22.8(0.90)	22.0(0.87)	20.6(0.81)	9.5(0.37)	19.1(0.75)	33.0(1.30)
15	1/2	-ME-MT15-MN8	38.0(1.50)	24.4(0.96)	25.0(0.98)	23.8(0.94)	11.9(0.47)	19.1(0.75)	35.1(1.38)
16	1/2	-ME-MT16-MN8	38.0(1.50)	24.4(0.96)	25.0(0.98)	23.8(0.94)	11.9(0.47)	19.1(0.75)	35.1(1.38)
16	3/4	-ME-MT16-MN12	39.8(1.57)	24.4(0.96)	25.0(0.98)	27.0(1.06)	12.7(0.50)	19.1(0.75)	36.8(1.45)
18	1/2	-ME-MT18-MN8	39.8(1.57)	24.4(0.96)	30.0(1.18)	27.0(1.06)	11.9(0.47)	19.1(0.75)	36.8(1.45)
18	3/4	-ME-MT18-MN12	39.8(1.57)	24.4(0.96)	30.0(1.18)	27.0(1.06)	15.1(0.59)	19.1(0.75)	36.8(1.45)
20	1/2	-ME-MT20-MN8	44.6(1.76)	26.0(1.02)	32.0(1.26)	34.9(1.37)	11.9(0.47)	19.1(0.75)	41.7(1.64)
20	3/4	-ME-MT20-MN12	44.6(1.76)	26.0(1.02)	32.0(1.26)	34.9(1.37)	15.9(0.63)	19.1(0.75)	41.7(1.64)
22	3/4	-ME-MT22-MN12	44.6(1.76)	26.0(1.02)	32.0(1.26)	34.9(1.37)	15.9(0.63)	19.1(0.75)	41.7(1.64)
22	1	-ME-MT22-MN16	44.6(1.76)	26.0(1.02)	32.0(1.26)	34.9(1.37)	18.3(0.72)	23.9(0.94)	46.5(1.83)
25	1	-ME-MT25-MN16	49.1(1.93)	31.3(1.23)	38.0(1.50)	34.9(1.37)	21.8(0.86)	23.9(0.94)	46.5(1.83)
30	1 1/4	-ME-MT30-MN20	69.9(2.75)	39.6(1.56)	50.0(1.97)	42.9(1.69)	26.2(1.03)	23.9(0.94)	53.1(2.09)
32	1 1/4	-ME-MT32-MN20	72.3(2.85)	42.0(1.65)	50.0(1.97)	42.9(1.69)	27.8(1.09)	23.9(0.94)	53.1(2.09)
38	1 1/2	-ME-MT38-MN24	84.0(3.31)	49.4(1.94)	60.0(2.36)	50.8(2.00)	33.7(1.33)	26.2(1.03)	60.4(2.38)

Metric Tube to RT Thread

T-Tube O.D.(mm)	P-RT SIZE	Basic Ordering Number	Dimension,mm (in)						
			L	C	D	F	E	B	Lx
3	1/8	-ME-MT3-RT2	23.6(0.93)	12.9(0.51)	12.0(0.47)	11.1(0.44)	2.4(0.09)	9.7(0.38)	17.8(0.70)
4	1/8	-ME-MT4-RT2	25.4(1.00)	13.7(0.54)	12.0(0.47)	12.7(0.50)	2.4(0.09)	9.7(0.38)	18.8(0.74)
6	1/4	--ME-MT6-RT4	27.0(1.06)	15.3(0.60)	14.0(0.55)	12.7(0.50)	4.8(0.19)	14.2(0.56)	23.4(0.92)
8	1/4	-ME-MT8-RT4	28.8(1.13)	16.2(0.64)	16.0(0.63)	14.3(0.56)	6.4(0.25)	14.2(0.56)	24.4(0.96)
10	3/8	-ME-MT10-RT6	31.5(1.24)	17.2(0.68)	19.0(0.75)	17.5(0.69)	7.9(0.31)	14.2(0.56)	26.2(1.03)
12	3/8	-ME-MT12-RT6	36.0(1.42)	22.8(0.90)	22.0(0.87)	20.6(0.81)	9.5(0.37)	14.2(0.56)	28.2(1.11)
12	1/2	-ME-MT12-RT8	36.0(1.42)	22.8(0.90)	22.0(0.87)	20.6(0.81)	0.5(0.02)	19.1(0.75)	33.0(1.30)
15	1/2	-ME-MT15-RT8	38.1(1.50)	24.4(0.90)	25.0(0.98)	23.8(0.94)	11.9(0.47)	19.1(0.75)	35.1(1.38)
16	1/2	-ME-MT16-RT8	38.0(1.50)	24.4(0.90)	25.0(0.98)	23.8(0.94)	11.9(0.47)	19.1(0.75)	35.1(1.38)
18	1/2	-ME-MT18-RT8	39.8(1.57)	24.4(0.90)	30.0(1.18)	27.0(1.06)	11.9(0.47)	19.1(0.75)	36.8(1.45)
20	3/4	-ME-MT20-RT12	44.6(1.76)	26.0(0.90)	32.0(1.26)	34.9(1.37)	15.9(0.63)	19.1(0.75)	41.7(1.64)
22	3/4	-ME-MT22-RT12	44.6(1.76)	26.0(0.90)	32.0(1.26)	34.9(1.37)	15.9(0.63)	19.1(0.75)	41.7(1.64)
25	1	-ME-MT25-RT16	49.1(1.93)	31.3(0.90)	38.0(1.50)	34.9(1.37)	21.8(0.86)	23.9(0.94)	46.5(1.83)
28	1	-ME-MT28-RT16	64.0(2.52)	36.6(0.90)	46.0(1.81)	42.9(1.69)	21.8(0.86)	23.9(0.94)	53.1(2.09)

45° Male Elbows

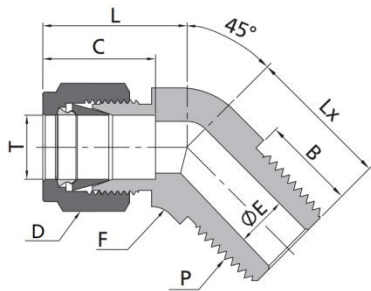

Fractional Tube to NPT Thread

T-Tube O.D.(in.)	P-NPT SIZE	Basic Ordering Number	Dimension,in(mm)						
			L	C	D	F	E	B	Lx
1/16	1/16	-MV-FT1-MN1	0.62(15.7)	0.34(8.6)	0.31(7.9)	0.37(9.5)	0.05(1.3)	0.38(9.7)	0.57(14.5)
1/8	1/8	-MV-FT2-MN2	0.82(20.8)	0.50(12.7)	0.44(11.1)	0.44(11.1)	0.09(2.3)	0.38(9.7)	0.66(16.8)
3/16	1/8	-MV-FT3-MN2	0.85(21.6)	0.54(13.7)	0.50(12.7)	0.44(11.1)	0.12(3.0)	0.38(9.7)	0.58(14.7)
1/4	1/8	-MV-FT4-MN2	0.97(24.6)	0.60(15.2)	0.56(14.3)	0.50(12.7)	0.19(4.8)	0.38(9.7)	0.65(16.5)
1/4	1/4	-MV-FT4-MN4	0.97(24.6)	0.60(15.2)	0.56(14.3)	0.50(12.7)	0.19(4.8)	0.56(14.2)	0.83(21.1)
5/16	1/8	-MV-FT5-MN2	1.03(26.1)	0.64(16.3)	0.63(15.9)	0.56(14.3)	0.19(4.8)	0.38(9.7)	0.66(16.8)
3/8	1/8	-MV-FT6-MN2	1.10(27.9)	0.66(16.8)	0.69(17.5)	0.63(15.9)	0.19(4.8)	0.38(9.7)	0.72(18.3)
3/8	1/4	-MV-FT6-MN4	1.10(27.9)	0.66(16.8)	0.69(17.5)	0.63(15.9)	0.28(7.1)	0.56(14.2)	0.90(22.9)
3/8	3/8	-MV-FT6-MN6	1.15(29.2)	0.66(16.8)	0.69(17.5)	0.81(20.6)	0.28(7.1)	0.75(19.1)	0.95(24.1)
1/2	3/8	-MV-FT8-MN6	1.26(32.0)	0.90(22.9)	0.87(22.2)	0.81(20.6)	0.38(9.7)	0.75(19.1)	0.95(24.1)
5/8	1/2	-V-FT10-MN8	1.21(30.7)	0.96(24.4)	1.00(25.4)	0.94(23.8)	0.47(11.9)	0.75(19.1)	1.17(29.7)
3/4	3/4	--MV-FT12-MN12	1.34(34.0)	0.96(24.4)	1.13(28.6)	1.06(27.0)	0.62(15.7)	0.75(19.1)	1.22(31.0)
7/8	3/4	-MV-FT14-MN12	1.59(40.4)	1.02(25.9)	1.25(31.8)	1.25(31.8)	0.62(15.7)	0.75(19.1)	1.27(32.3)
1	1	-MV-FT16-MN16	1.59(40.4)	1.23(31.2)	1.50(38.1)	1.37(34.9)	0.88(22.4)	0.94(23.9)	1.49(37.8)

Metric Tube to NPT Thread

T-Tube O.D.(mm)	P-NPT SIZE	Basic Ordering Number	Dimension,mm(in)						
			L	C	D	F	E	B	Lx
6	1/8	-MV-MT6-MN2	23.4(0.92)	15.3(0.60)	14.0(0.55)	12.7(0.50)	4.8(0.19)	9.7(0.38)	16.8(0.66)
6	1/4	-MV-MT6-MN4	23.4(0.92)	15.3(0.60)	14.0(0.55)	12.7(0.50)	4.8(0.19)	14.2(0.56)	21.8(0.86)
8	1/8	-MV-MT8-MN2	24.3(0.96)	16.2(0.64)	16.0(0.63)	15.9(0.63)	4.8(0.19)	9.7(0.38)	16.8(0.66)
10	1/4	-MV-MT10-MN4	26.6(1.05)	17.2(0.68)	19.0(0.75)	17.5(0.69)	7.9(0.31)	14.2(0.56)	24.1(0.95)
12	3/8	-MV-MT12-MN6	29.1(1.15)	22.8(0.90)	22.0(0.87)	20.6(0.81)	9.5(0.37)	19.1(0.75)	24.1(0.95)
12	1/2	-MV-MT12-MN8	30.7(1.21)	22.8(0.90)	22.0(0.87)	20.6(0.81)	9.5(0.37)	19.1(0.75)	29.7(1.17)
16	1/2	-MV-MT16-MN8	30.7(1.21)	24.4(0.96)	25.0(0.98)	23.8(0.94)	11.9(0.47)	19.1(0.75)	29.7(1.17)
18	3/4	--MV-MT18-MN12	34.0(1.34)	24.4(0.96)	30.0(1.18)	27.0(1.06)	15.1(0.59)	19.1(0.75)	1.22(31.0)
22	3/4	-MV-MT22-MN12	40.4(1.59)	26.0(1.02)	32.0(1.26)	34.9(1.37)	15.9(0.63)	19.1(0.75)	32.3(1.27)
25	1	-MV-MT25-MN16	40.4(1.59)	31.3(1.23)	38.0(1.50)	34.9(1.37)	21.8(0.86)	23.9(0.94)	37.8(1.49)

Ajustable Male Elbows

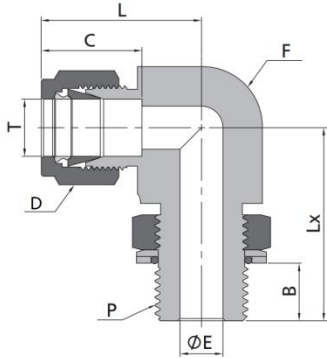

Fractional Tube to SAE/MS Thread

T-Tube O.D.(in.)	P-SAE/MS SIZE	Basic Ordering Number	Dimension,in(mm)						
			L	B	C	D	E	F	Lx
1/4	7/16-20	-AME-FT4-ST7	1.12(28.4)	0.39(9.9)	0.60(15.2)	0.56(14.3)	0.19(4.8)	0.50(12.7)	1.12(28.4)
1/4	9/16-18	-AME-FT4-ST9	1.20(30.5)	0.44(11.2)	0.60(15.2)	0.56(14.3)	0.19(4.8)	0.63(15.9)	1.27(32.3)
5/16	1/2-20	-AME-FT5-ST8	1.19(30.2)	0.39(9.9)	0.64(16.3)	0.63(15.9)	0.23(5.8)	0.56(14.3)	1.16(29.5)
3/8	7/16-20	-AME-FT6-ST7	1.31(33.3)	0.39(9.9)	0.66(16.8)	0.69(17.5)	0.20(5.1)	0.63(15.9)	1.24(31.5)
3/8	9/16-18	-AME-FT6-ST9	1.26(32.0)	0.44(11.2)	0.66(16.8)	0.69(17.5)	0.28(7.1)	0.63(15.9)	1.27(32.3)
3/8	3/4-16	-AME-FT6-ST12	1.37(34.8)	0.50(12.7)	0.66(16.8)	0.69(17.5)	0.28(7.1)	0.81(20.6)	1.49(37.8)
1/2	9/16-18	-AME-FT8-ST9	1.48(37.6)	0.44(11.2)	0.90(22.9)	0.87(22.2)	0.28(7.1)	0.81(20.6)	1.48(37.5)
1/2	3/4-16	-AME-FT8-ST12	1.48(37.6)	0.50(12.7)	0.90(22.9)	0.87(22.2)	0.41(10.4)	0.81(20.6)	1.49(37.8)
5/8	7/8-14	-AME-FT10-ST14	1.56(39.6)	0.56(14.2)	0.96(24.4)	1.00(25.4)	0.50(12.7)	0.94(23.8)	1.71(43.4)
3/4	1 1/16-12	-AME-FT12-ST17	1.63(41.4)	0.66(16.8)	0.96(24.4)	1.13(28.6)	0.62(15.7)	1.06(27.0)	1.92(48.8)
7/8	1 3/16-12	-AME-FT14-ST19	1.70(43.2)	0.66(16.8)	1.02(25.9)	1.25(31.8)	0.72(18.3)	1.19(30.2)	1.99(50.5)
1	1 5/16-12	-AME-FT16-ST21	1.99(50.5)	0.66(16.8)	1.23(31.2)	1.50(38.1)	0.88(22.4)	1.37(34.9)	2.11(53.6)
1 1/4	1 5/8-12	-AME-FT20-ST26	2.67(67.8)	0.66(16.8)	1.62(41.1)	1.87(47.6)	1.09(27.7)	1.69(42.9)	2.29(58.2)
1 1/2	1 7/8-12	-AME-FT24-ST30	3.07(78.0)	0.66(16.8)	1.97(50.0)	2.25(57.2)	1.34(34.0)	2.00(50.8)	2.38(60.5)

Fractional Tube to ISO Parallel Thread

T-Tube O.D.(in.)	P-BSP SIZE	Basic Ordering Number	Dimension,in(mm)						
			L	B	C	D	E	F	Lx
1/4	1/8	-AME-FT4-PP2	1.06(26.9)	0.32(8.1)	0.60(15.2)	0.56(14.3)	0.16(4.1)	0.50(12.7)	1.04(26.4)
1/4	1/4	-AME-FT4-PP4	1.14(29.0)	0.36(9.1)	0.60(15.2)	0.56(14.3)	0.19(4.8)	0.63(15.9)	1.27(32.3)
3/8	1/4	-AME-FT6-PP4	1.20(30.5)	0.36(9.1)	0.66(16.8)	0.69(17.5)	0.23(5.8)	0.63(15.9)	1.27(32.3)
3/8	3/8	-AME-FT6-PP6	1.31(33.3)	0.37(9.4)	0.66(16.8)	0.69(17.5)	0.28(7.1)	0.81(20.6)	1.46(37.1)
1/2	1/4	-AME-FT8-PP4	1.42(36.1)	0.36(9.1)	0.90(22.9)	0.87(22.2)	0.23(5.8)	0.81(20.6)	1.38(35.1)
1/2	3/8	-AME-FT8-PP6	1.42(36.1)	0.37(9.4)	0.90(22.9)	0.87(22.2)	0.31(7.9)	0.81(20.6)	1.46(37.1)
1/2	1/2	-AME-FT8-PP8	1.50(38.1)	0.51(13.0)	0.90(22.9)	0.87(22.2)	0.41(10.4)	0.94(23.8)	1.71(43.4)
5/8	1/2	-AME-FT10-PP8	1.50(38.1)	0.51(13.0)	0.96(24.4)	1.00(25.4)	0.47(11.9)	0.94(23.8)	1.71(43.4)
3/4	1/2	-AME-FT12-PP8	1.57(39.9)	0.51(13.0)	0.96(24.4)	1.13(28.6)	0.47(11.9)	1.06(27.0)	1.78(45.2)
3/4	3/4	-AME-FT12-PP12	1.57(39.9)	0.51(13.0)	0.96(24.4)	1.13(28.6)	0.62(15.7)	1.06(27.0)	1.92(48.8)
1	3/4	-AME-FT16-PP12	1.93(49.0)	0.51(13.0)	1.23(31.2)	1.50(38.1)	0.62(15.7)	1.37(34.9)	2.10(53.3)
1	1	-AME-FT16-PP16	1.93(49.0)	0.55(14.0)	1.23(31.2)	1.50(38.1)	0.78(19.8)	1.37(34.9)	2.11(53.6)

Metric Tube to ISO Parallel Thread

T-Tube O.D.(mm)	P-BSP SIZE	Basic Ordering Number	Dimension,mm(in)						
			L	B	C	D	E	F	Lx
6	1/8	-AME-MT6-PP2	27.0(1.06)	8.1(0.32)	15.3(0.60)	14.0(0.55)	4.0(0.16)	12.7(0.50)	26.4(1.04)
6	1/4	-AME-MT6-PP4	29.0(1.14)	9.1(0.36)	15.3(0.60)	14.0(0.55)	4.8(0.19)	15.9(0.63)	32.3(1.27)
8	1/8	-AME-MT8-PP2	28.8(1.13)	8.1(0.32)	16.2(0.64)	16.0(0.63)	4.0(0.16)	14.3(0.56)	27.4(1.08)
8	1/4	-AME-MT8-PP4	29.9(1.18)	9.1(0.36)	16.2(0.64)	16.0(0.63)	5.9(0.23)	15.9(0.63)	32.2(1.27)
10	1/4	-AME-MT10-PP4	33.5(1.32)	9.1(0.36)	17.2(0.68)	19.0(0.75)	5.9(0.23)	20.6(0.81)	35.0(1.38)
10	3/8	-AME-MT10-PP6	33.5(1.32)	9.4(0.37)	17.2(0.68)	19.0(0.75)	7.9(0.31)	20.6(0.81)	37.1(1.46)
12	1/4	-AME-MT12-PP4	36.0(1.42)	9.1(0.36)	22.8(0.90)	22.0(0.87)	5.9(0.23)	20.6(0.81)	35.0(1.38)
12	3/8	-AME-MT12-PP6	36.0(1.42)	9.4(0.37)	22.8(0.90)	22.0(0.87)	7.9(0.31)	20.6(0.81)	37.1(1.46)
12	1/2	-AME-MT12-PP8	38.0(1.50)	13.0(0.51)	22.8(0.90)	22.0(0.87)	9.5(0.37)	23.8(0.94)	43.4(1.71)
12	3/4	-AME-MT12-PP12	39.8(1.57)	13.0(0.51)	22.8(0.90)	22.0(0.87)	9.5(0.37)	27.0(1.06)	48.8(1.92)

45° Adjustable Male Elbows

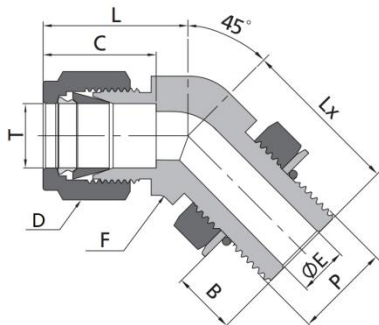

Fractional Tube to SAE/MS Thread									
T-Tube O.D.(in.)	P-SAE/MS SIZE	Basic Ordering Number	Dimension,in(mm)						
			L	B	C	D	E	F	Lx
1/4	7/16-20	-AMV-FT4-ST7	1.01(25.7)	0.39(9.9)	0.60(15.2)	0.56(14.3)	0.19(4.8)	0.50(12.7)	1.01(25.7)
3/8	9/16-18	-AMV-FT6-ST9	1.10(27.9)	0.44(11.2)	0.66(16.8)	0.69(17.5)	0.28(7.1)	0.63(15.9)	1.11(28.2)
1/2	3/4-16	-AMV-FT8-ST12	1.26(32.0)	0.50(12.7)	0.90(22.9)	0.87(22.2)	0.41(10.4)	0.81(20.6)	1.27(32.3)
3/4	1 1/16-12	-AMV-FT12-ST17	1.57(39.9)	0.66(16.8)	0.96(24.4)	1.13(28.6)	0.62(15.7)	1.06(27.0)	1.86(47.2)
1	1 5/16-12	-AMV-FT16-ST21	1.87(47.5)	0.66(16.8)	1.23(31.2)	1.50(38.1)	0.88(22.4)	1.37(34.9)	1.99(50.5)

Fractional Tube to ISO Parallel Thread									
T-Tube O.D.(in.)	P-BSP SIZE	Basic Ordering Number	Dimension,in(mm)						
			L	B	C	D	E	F	Lx
1/4	1/8	-AMV-FT4-PP2	1.06(26.9)	0.32(8.1)	0.60(15.2)	0.56(14.3)	0.16(4.1)	0.50(12.7)	1.04(26.4)
3/8	1/4	-AMV-FT6-PP4	1.20(30.5)	0.36(9.1)	0.66(16.8)	0.69(17.5)	0.23(5.8)	0.63(15.9)	1.27(32.3)
1/2	1/2	-AMV-FT8-PP8	1.50(38.1)	0.51(13.0)	0.90(22.9)	0.87(22.2)	0.41(10.4)	0.94(23.8)	1.71(43.4)
3/4	3/4	-AMV-FT12-PP12	1.57(39.9)	0.51(13.0)	0.96(24.4)	1.13(28.6)	0.62(15.7)	1.06(27.0)	1.92(48.8)
1	1	-AMV-FT16-PP16	1.93(49.0)	0.55(14.0)	1.23(31.2)	1.50(38.1)	0.78(19.8)	1.37(34.9)	2.11(53.6)

Female Elbows

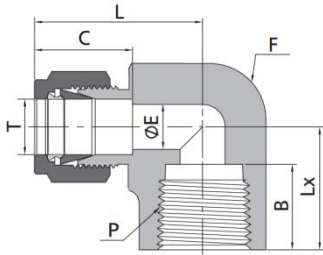

Fractional Tube to NPT Thread

T-Tube O.D.(in.)	P-NPT SIZE	Basic Ordering Number	Dimension,in(mm)						
			L	B	C	D	E	F	Lx
1/16	1/16	-FE-FT1-FN1	0.71(18.0)	0.39(9.9)	0.34(8.6)	0.31(7.9)	0.05(1.3)	0.44(11.1)	0.56(14.2)
1/16	1/8	-FE-FT1-FN2	0.81(20.6)	0.41(10.4)	0.34(8.6)	0.31(7.9)	0.05(1.3)	0.56(14.3)	0.75(19.1)
1/8	1/8	-FE-FT2-FN2	0.97(24.6)	0.41(10.4)	0.50(12.7)	0.44(11.1)	0.09(2.3)	0.56(14.3)	0.75(19.1)
1/8	1/4	-FE-FT2-FN4	1.08(27.4)	0.59(15.0)	0.50(12.7)	0.44(11.1)	0.09(2.3)	0.69(17.5)	0.88(22.4)
3/16	1/8	-FE-FT3-FN2	1.00(25.4)	0.41(10.4)	0.54(13.7)	0.50(12.7)	0.12(3.0)	0.5(12.7)	0.75(19.1)
1/4	1/8	-FE-FT4-FN2	1.06(26.9)	0.41(10.4)	0.60(15.2)	0.56(14.3)	0.19(4.8)	0.56(14.3)	0.75(19.1)
1/4	1/4	-FE-FT4-FN4	1.17(29.7)	0.59(15.0)	0.60(15.2)	0.56(14.3)	0.19(4.8)	0.69(17.5)	0.88(22.4)
1/4	3/8	-FE-FT4-FN6	1.25(31.8)	0.59(15.0)	0.60(15.2)	0.56(14.3)	0.19(4.8)	0.81(20.6)	0.88(22.4)
1/4	1/2	-FE-FT4-FN8	1.36(34.5)	0.78(19.8)	0.60(15.2)	0.56(14.3)	0.19(4.8)	1.00(25.4)	1.12(28.4)
5/16	1/8	-FE-FT-FN2	1.13(28.7)	0.41(10.4)	0.64(16.3)	0.63(15.9)	0.25(6.4)	0.56(14.3)	0.75(19.1)
5/16	1/4	-FE-FT5-FN4	1.20(30.5)	0.59(15.0)	0.64(16.3)	0.63(15.9)	0.25(6.4)	0.69(17.5)	0.88(22.4)
3/8	1/8	-FE-FT6-FN2	1.20(30.5)	0.41(10.4)	0.66(16.8)	0.69(17.5)	0.28(7.1)	0.63(15.9)	0.75(19.1)
3/8	1/4	-FE-FT6-FN4	1.23(31.2)	0.59(15.0)	0.66(16.8)	0.69(17.5)	0.28(7.1)	0.69(17.5)	0.88(22.4)
3/8	3/8	-FE-FT6-FN6	1.31(33.3)	0.59(15.0)	0.66(16.8)	0.69(17.5)	0.28(7.1)	0.81(20.6)	0.88(22.4)
3/8	1/2	-FE-FT6-FN8	1.42(36.1)	0.78(19.8)	0.66(16.8)	0.69(17.5)	0.28(7.1)	1.00(25.4)	1.12(28.4)
1/2	1/4	-FE-FT8-FN4	1.42(36.1)	0.59(15.0)	0.90(22.9)	0.87(22.2)	0.41(10.4)	0.81(20.6)	0.88(22.4)
1/2	3/8	-FE-FT8-FN6	1.42(36.1)	0.59(15.0)	0.90(22.9)	0.87(22.2)	0.41(10.4)	0.81(20.6)	0.88(22.4)
1/2	1/2	-FE-FT8-FN8	1.53(38.9)	0.78(19.8)	0.90(22.9)	0.87(22.2)	0.41(10.4)	1.00(25.4)	1.12(28.4)
5/8	3/8	-FE-FT10-FN6	1.50(38.1)	0.59(15.0)	0.96(24.4)	1.00(25.4)	0.50(12.7)	0.94(23.8)	0.88(22.4)
5/8	1/2	-FE-FT10-FN8	1.57(39.9)	0.78(19.8)	0.96(24.4)	1.00(25.4)	0.50(12.7)	1.06(27.0)	1.12(28.4)
3/4	1/2	-FE-FT12-FN8	1.57(39.9)	0.78(19.8)	0.96(24.4)	1.13(28.6)	0.62(15.7)	1.06(27.0)	1.12(28.4)
3/4	3/4	-FE-FT12-FN12	1.76(44.7)	0.81(20.6)	0.96(24.4)	1.13(28.6)	0.62(15.7)	1.37(34.9)	1.25(31.8)
7/8	3/4	-FE-FT14-FN12	1.76(44.7)	0.81(20.6)	1.02(25.9)	1.25(31.8)	0.72(18.3)	1.37(34.9)	1.25(31.8)
1	3/4	-FE-FN16-FN12	1.93(49.0)	0.81(20.6)	1.23(31.2)	1.50(38.1)	0.88(22.4)	1.37(34.9)	1.25(31.8)
1	1	-FE-FT6-FN16	2.11(53.6)	1.00(25.4)	1.23(31.2)	1.50(38.1)	0.88(22.4)	1.69(42.9)	1.50(38.1)

Metric Tube to NPT Thread

T-Tube O.D.(mm)	P-NPT SIZE	Basic Ordering Number	Dimension,mm(in)						
			L	B	C	D	E	F	Lx
6	1/8	-FE-MT6-FN2	27.0(1.06)	10.4(0.41)	15.3(0.60)	14.0(0.55)	4.8(0.19)	12.7(0.50)	19.0(0.75)
6	1/4	-FE-MT6-FN4	29.8(1.17)	15.0(0.59)	15.3(0.60)	14.0(0.55)	4.8(0.19)	17.5(0.69)	22.4(0.88)
8	1/8	-FE-MT8-FN2	28.8(1.13)	10.4(0.41)	16.2(0.64)	16.0(0.63)	4.8(0.19)	14.3(0.56)	19.1(0.75)
8	1/4	-FE-MT8-FN4	30.6(1.20)	15.0(0.59)	16.2(0.64)	16.0(0.63)	6.4(0.25)	17.5(0.69)	22.4(0.88)
10	1/4	-FE-MT10-FN4	33.5(1.32)	15.0(0.59)	17.2(0.68)	19.0(0.75)	7.9(0.31)	20.6(0.81)	22.4(0.88)
10	3/8	-FE-MT10-FN6	33.5(1.32)	15.0(0.59)	17.2(0.68)	19.0(0.75)	7.9(0.31)	20.6(0.81)	22.4(0.88)
10	1/2	-FE-MT10-FN8	36.6(1.44)	19.8(0.78)	17.2(0.68)	19.0(0.75)	7.9(0.31)	25.4(1.00)	28.5(1.12)
12	1/4	-FE-MT12-FN4	36.0(1.42)	15.0(0.59)	22.8(0.90)	22.0(0.87)	7.9(0.31)	20.6(0.81)	22.4(0.88)
12	3/8	-FE-MT12-FN6	36.0(1.42)	15.0(0.59)	22.8(0.90)	22.0(0.87)	9.5(0.37)	20.6(0.81)	22.4(0.88)
12	1/2	-FE-MT12-FN8	38.8(1.53)	19.8(0.78)	22.8(0.90)	22.0(0.87)	9.5(0.37)	25.4(1.00)	28.4(1.12)
16	3/8	-FE-MT16-FN6	39.5(1.56)	15.0(0.59)	24.4(0.96)	25.0(0.98)	9.5(0.37)	27.0(1.06)	23.6(0.93)
16	1/2	-FE-MT16-FN8	39.5(1.56)	19.8(0.78)	24.4(0.96)	25.0(0.98)	12.7(0.50)	27.0(1.06)	28.5(1.12)

Union Tees

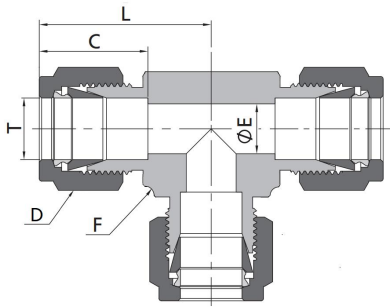

Fractional Tube						
T-Tube O.D.(in.)	Basic Ordering Number	Dimension, in. (mm)				
		L	C	D	F	E
1/16	-UT-FT1	0.70(17.8)	0.34(8.6)	0.31(7.9)	0.37(9.5)	0.05(1.3)
1/8	-UT-FT2	0.96(24.4)	0.50(12.7)	0.44(11.1)	0.37(9.5)	0.09(2.3)
3/16	-UT-FT3	0.96(24.4)	0.54(13.7)	0.50(12.7)	0.44(11.1)	0.12(3.0)
1/4	-UT-FT4	1.06(26.9)	0.60(15.2)	0.56(14.3)	0.50(12.7)	0.19(4.8)
5/16	-UT-FT5	1.17(29.7)	0.64(16.2)	0.63(15.9)	0.63(15.9)	0.25(6.4)
3/8	-UT-FT6	1.20(30.5)	0.66(16.8)	0.69(17.5)	0.63(15.9)	0.28(7.1)
1/2	-UT-FT8	1.42(36.1)	0.90(22.9)	0.87(22.2)	0.81(20.6)	0.41(10.4)
5/8	-UT-FT10	1.53(38.9)	0.96(24.4)	1.00(25.4)	1.00(25.4)	0.50(12.7)
3/4	-UT-FT12	1.57(39.9)	0.96(24.4)	1.13(28.6)	1.06(27.0)	0.62(15.7)
7/8	-UT-FT14	1.76(44.7)	1.02(25.9)	1.25(31.8)	1.37(34.9)	0.72(18.3)
1	-UT-FT16	1.93(49.0)	1.23(31.2)	1.50(38.1)	1.37(34.9)	0.88(22.4)
1 1/8	-UT-FT18	2.17(55.1)	1.23(31.2)	1.81(46.0)	1.69(42.9)	0.97(24.6)
1 1/4	-UT-FT20	2.62(66.5)	1.62(41.1)	1.87(47.6)	1.69(42.9)	1.09(27.7)
1 1/2	-UT-FT24	3.07(78.0)	1.97(50.0)	2.25(57.2)	2.00(50.8)	1.34(34.0)

Metric Tube						
T-Tube O.D.(mm)	Basic Ordering Number	Dimension, mm (in.)				
		L	C	D	F	E
2	-UT-MT2	22.3(0.88)	12.9(0.51)	12.0(0.47)	9.5(0.37)	1.7(0.07)
3	-UT-MT3	22.3(0.88)	12.9(0.51)	12.0(0.47)	9.5(0.37)	2.4(0.09)
4	-UT-MT4	25.4(1.00)	13.7(0.54)	12.0(0.47)	12.7(0.50)	2.4(0.09)
6	-UT-MT6	27.0(1.06)	15.3(0.60)	14.0(0.55)	12.7(0.50)	4.8(0.19)
8	-UT-MT8	29.9(1.18)	16.2(0.64)	16.0(0.63)	15.9(0.63)	6.4(0.25)
10	-UT-MT10	31.5(1.24)	17.2(0.68)	19.0(0.75)	17.5(0.69)	7.9(0.31)
12	-UT-MT12	36.0(1.42)	22.8(0.90)	22.0(0.87)	20.6(0.81)	9.5(0.37)
14	-UT-MT14	38.8(1.53)	24.4(0.96)	25.0(0.98)	25.4(1.00)	11.1(0.44)
15	-UT-MT15	38.8(1.53)	24.4(0.96)	25.0(0.98)	25.4(1.00)	11.9(0.47)
16	-UT-MT16	38.8(1.53)	24.4(0.96)	25.0(0.98)	25.4(1.00)	12.7(0.50)
18	-UT-MT18	38.8(1.53)	24.4(0.96)	30.0(1.18)	27.0(1.06)	15.1(0.59)
20	-UT-MT20	44.6(1.76)	26.0(1.02)	32.0(1.26)	34.9(1.37)	15.9(0.63)
22	-UT-MT22	44.6(1.76)	26.0(1.02)	32.0(1.26)	34.9(1.37)	18.3(0.72)
25	-UT-MT25	49.1(1.93)	31.3(1.23)	38.0(1.50)	34.9(1.37)	21.8(0.86)
28	-UT-MT28	64.0(2.52)	36.6(1.44)	46.0(1.81)	42.9(1.69)	21.8(0.86)
30	-UT-MT30	69.9(2.75)	39.6(1.56)	50.0(1.97)	42.9(1.69)	26.2(1.03)
32	-UT-MT32	72.3(2.85)	42.0(1.65)	50.0(1.97)	42.9(1.69)	28.6(1.13)
38	-UT-MT38	84.0(3.31)	49.4(1.94)	60.0(2.36)	50.8(2.00)	33.7(1.33)

Reducing Union Tees

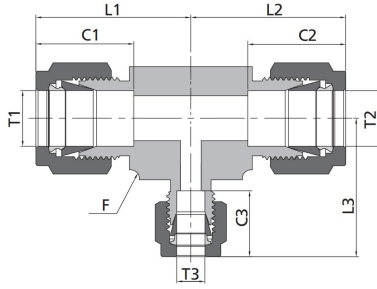

Fractional Tube											
T1- O.D. (in.)	T2- O.D. (in.)	T3- O.D. (in.)	Basic Ordering Number	Dimension, in. (mm)							
				L1	L2	L3	C1	C2	C3	F	
1/4	1/4	1/8	-RUT-FT4-FT4-FT2	1.05(26.7)	1.05(26.7)	0.96(24.4)	0.60(15.2)	0.60(15.2)	0.50(12.7)	0.50(12.7)	
3/8	1/4	1/4	-RUT-FT6-FT4-FT4	1.20(30.5)	1.14(29.0)	1.14(29.0)	0.66(16.8)	0.60(15.2)	0.60(15.2)	0.63(15.9)	
3/8	1/4	3/8	-RUT-FT6-FT4-FT6	1.20(30.5)	1.14(29.0)	1.20(30.5)	0.66(16.8)	0.60(15.2)	0.66(16.8)	0.63(15.9)	
3/8	3/8	1/4	-RUT-FT6-FT6-FT4	1.20(30.5)	1.20(30.5)	1.14(29.0)	0.66(16.8)	0.66(16.8)	0.60(15.2)	0.63(15.9)	
1/2	1/4	1/4	-RUT-FT8-FT4-FT4	1.42(36.1)	1.25(31.8)	1.25(31.8)	0.90(22.9)	0.60(15.2)	0.60(15.2)	0.81(20.6)	
1/2	1/4	1/2	-RUT-FT8-FT4-FT8	1.42(36.1)	1.25(31.8)	1.42(36.1)	0.90(22.9)	0.60(15.2)	0.90(22.9)	0.81(20.6)	
1/2	3/8	3/8	-RUT-FT8-FT6-FT6	1.42(36.1)	1.31(33.3)	1.31(33.3)	0.90(22.9)	0.66(16.8)	0.66(16.8)	0.81(20.6)	
1/2	3/8	1/2	-RUT-FT8-FT6-FT8	1.42(36.1)	1.31(33.3)	1.42(36.1)	0.90(22.9)	0.66(16.8)	0.90(22.9)	0.81(20.6)	
1/2	1/2	1/4	-RUT-FT8-FT8-FT4	1.42(36.1)	1.42(36.1)	1.25(31.8)	0.90(22.9)	0.90(22.9)	0.60(15.2)	0.81(20.6)	
1/2	1/2	3/8	-RUT-FT8-FT8-FT6	1.42(36.1)	1.42(36.1)	1.31(33.3)	0.90(22.9)	0.90(22.9)	0.66(16.8)	0.81(20.6)	
5/8	3/8	3/8	-RUT-FT10-FT6-FT6	1.53(38.9)	1.42(36.1)	1.42(36.1)	0.96(24.4)	0.66(16.8)	0.66(16.8)	1.00(25.4)	
5/8	3/8	1/2	-RUT-FT10-FT6-FT8	1.53(38.9)	1.42(36.1)	1.53(38.9)	0.96(24.4)	0.66(16.8)	0.90(22.9)	1.00(25.4)	
5/8	1/2	1/2	-RUT-FT10-FT8-FT8	1.53(38.9)	1.53(38.9)	1.53(38.9)	0.96(24.4)	0.90(22.9)	0.90(22.9)	1.00(25.4)	
5/8	5/8	3/8	-RUT-FT10-FT10-FT6	1.53(38.9)	1.53(38.9)	1.42(36.1)	0.96(24.4)	0.96(24.4)	0.66(16.8)	1.00(25.4)	
5/8	5/8	1/2	-RUT-FT10-FT10-FT8	1.53(38.9)	1.53(38.9)	1.53(38.9)	0.96(24.4)	0.96(24.4)	0.90(22.9)	1.00(25.4)	
3/4	3/8	3/8	-RUT-FT12-FT6-FT6	1.56(39.6)	1.45(36.9)	1.45(36.9)	0.96(24.4)	0.66(16.8)	0.66(16.8)	1.06(27.0)	
3/4	1/2	3/8	-RUT-FT12-FT8-FT6	1.56(39.6)	1.56(39.6)	1.45(36.9)	0.96(24.4)	0.90(22.9)	0.66(16.8)	1.06(27.0)	
3/4	1/2	1/2	-RUT-FT12-FT8-FT8	1.56(39.6)	1.56(39.6)	1.56(39.6)	0.96(24.4)	0.90(22.9)	0.90(22.9)	1.06(27.0)	
3/4	5/8	1/2	-RUT-FT12-FT10-FT8	1.56(39.6)	1.56(39.6)	1.56(39.6)	0.96(24.4)	0.96(24.4)	0.90(22.9)	1.06(27.0)	
3/4	5/8	5/8	-RUT-FT12-FT10-FT10	1.56(39.6)	1.56(39.6)	1.56(39.6)	0.96(24.4)	0.96(24.4)	0.96(24.4)	1.06(27.0)	
3/4	3/4	1/4	-RUT-FT12-FT12-FT4	1.56(39.6)	1.56(39.6)	1.38(35.1)	0.96(24.4)	0.96(24.4)	0.60(15.2)	1.06(27.0)	
3/4	3/4	3/8	-RUT-FT12-FT12-FT6	1.56(39.6)	1.56(39.6)	1.45(36.9)	0.96(24.4)	0.96(24.4)	0.66(16.8)	1.06(27.0)	
3/4	3/4	1/2	-RUT-FT12-FT12-FT8	1.56(39.6)	1.56(39.6)	1.56(39.6)	0.96(24.4)	0.96(24.4)	0.90(22.9)	1.06(27.0)	
3/4	3/4	5/8	-RUT-FT12-FT12-FT10	1.56(39.6)	1.56(39.6)	1.56(39.6)	0.96(24.4)	0.96(24.4)	0.96(24.4)	1.06(27.0)	
7/8	1/2	3/4	-RUT-FT14-FT8-FT12	1.76(44.7)	1.76(44.7)	1.76(44.7)	1.02(25.9)	0.90(22.9)	0.96(24.4)	1.37(34.9)	
7/8	5/8	3/8	-RUT-FT14-FT10-FT6	1.76(44.7)	1.76(44.7)	1.65(41.9)	1.02(25.9)	0.96(24.4)	0.66(16.8)	1.37(34.9)	
7/8	3/4	1/2	-RUT-FT14-FT12-FT8	1.76(44.7)	1.76(44.7)	1.76(44.7)	1.02(25.9)	0.96(24.4)	0.90(22.9)	1.37(34.9)	
7/8	3/4	3/4	-RUT-FT14-FT12-FT12	1.76(44.7)	1.76(44.7)	1.76(44.7)	1.02(25.9)	0.96(24.4)	0.96(24.4)	1.37(34.9)	
7/8	7/8	1/4	-RUT-FT14-FT14-FT4	1.76(44.7)	1.76(44.7)	1.59(40.4)	1.02(25.9)	1.02(25.9)	0.60(15.2)	1.37(34.9)	
7/8	7/8	3/8	-RUT-FT14-FT14-FT6	1.76(44.7)	1.76(44.7)	1.65(41.9)	1.02(25.9)	1.02(25.9)	0.66(16.8)	1.37(34.9)	
1	3/8	3/8	-RUT-FT16-FT6-FT6	1.94(49.3)	1.65(41.9)	1.65(41.9)	1.23(31.2)	0.66(16.8)	0.66(16.8)	1.37(34.9)	
1	1/2	1/4	-RUT-FT16-FT8-FT4	1.94(49.3)	1.76(44.7)	1.59(40.4)	1.23(31.2)	0.90(22.9)	0.60(15.2)	1.37(34.9)	
1	1/2	3/8	-RUT-FT16-FT8-FT6	1.94(49.3)	1.76(44.7)	1.65(41.9)	1.23(31.2)	0.90(22.9)	0.66(16.8)	1.37(34.9)	
1	1/2	1/2	-RUT-FT16-FT8-FT8	1.94(49.3)	1.76(44.7)	1.76(44.7)	1.23(31.2)	0.90(22.9)	0.90(22.9)	1.37(34.9)	
1	1/2	1	-RUT-FT16-FT8-FT16	1.94(49.3)	1.76(44.7)	1.94(49.3)	1.23(31.2)	0.90(22.9)	1.23(31.2)	1.37(34.9)	
1	3/4	3/8	-RUT-FT16-FT12-FT6	1.94(49.3)	1.76(44.7)	1.65(41.9)	1.23(31.2)	0.96(24.4)	0.66(16.8)	1.37(34.9)	
1	3/4	1/2	-RUT-FT16-FT12-FT8	1.94(49.3)	1.76(44.7)	1.76(44.7)	1.23(31.2)	0.96(24.4)	0.90(22.9)	1.37(34.9)	
1	3/4	5/8	-RUT-FT16-FT12-FT10	1.94(49.3)	1.76(44.7)	1.76(44.7)	1.23(31.2)	0.96(24.4)	0.96(24.4)	1.37(34.9)	
1	3/4	1	-RUT-FT16-FT12-FT16	1.94(49.3)	1.76(44.7)	1.94(49.3)	1.23(31.2)	0.96(24.4)	1.23(31.2)	1.37(34.9)	
1	7/8	1/4	-RUT-FT16-FT14-FT4	1.94(49.3)	1.76(44.7)	1.59(40.4)	1.23(31.2)	1.02(25.9)	0.60(15.2)	1.37(34.9)	
1	7/8	3/8	-RUT-FT16-FT14-FT6	1.94(49.3)	1.76(44.7)	1.65(41.9)	1.23(31.2)	1.02(25.9)	0.66(16.8)	1.37(34.9)	
1	7/8	1/2	-RUT-FT16-FT14-FT8	1.94(49.3)	1.76(44.7)	1.76(44.7)	1.23(31.2)	1.02(25.9)	0.90(22.9)	1.37(34.9)	
1	7/8	3/4	-RUT-FT16-FT14-FT12	1.94(49.3)	1.76(44.7)	1.76(44.7)	1.23(31.2)	1.02(25.9)	0.96(24.4)	1.37(34.9)	
1	7/8	7/8	-RUT-FT16-FT14-FT14	1.94(49.3)	1.76(44.7)	1.76(44.7)	1.23(31.2)	1.02(25.9)	1.02(25.9)	1.37(34.9)	
1	1	1/4	-RUT-FT16-FT16-FT4	1.94(49.3)	1.94(49.3)	1.59(40.4)	1.23(31.2)	1.23(31.2)	0.60(15.2)	1.37(34.9)	
1	1	3/8	-RUT-FT16-FT16-FT6	1.94(49.3)	1.94(49.3)	1.65(41.9)	1.23(31.2)	1.23(31.2)	0.66(16.8)	1.37(34.9)	
1	1	1/2	-RUT-FT16-FT16-FT8	1.94(49.3)	1.94(49.3)	1.76(44.7)	1.23(31.2)	1.23(31.2)	0.90(22.9)	1.37(34.9)	
1	1	5/8	-RUT-FT16-FT16-FT10	1.94(49.3)	1.94(49.3)	1.76(44.7)	1.23(31.2)	1.23(31.2)	0.96(24.4)	1.37(34.9)	
1	1	3/4	-RUT-FT16-FT16-FT12	1.94(49.3)	1.94(49.3)	1.76(44.7)	1.23(31.2)	1.23(31.2)	0.96(24.4)	1.37(34.9)	
1	1	7/8	-RUT-FT16-FT16-FT14	1.94(49.3)	1.94(49.3)	1.76(44.7)	1.23(31.2)	1.23(31.2)	1.02(25.9)	1.37(34.9)	
1 1/4	1 1/4	1	-RUT-FT20-FT20-FT16	2.67(67.8)	2.67(67.8)	2.17(55.1)	1.62(41.2)	1.62(41.2)	1.23(31.3)	1.69(42.9)	
1 1/2	1 1/2	1	-RUT-FT24-FT24-FT16	3.10(78.7)	3.10(78.7)	2.36(60.0)	1.97(50.0)	1.97(50.0)	1.23(31.3)	2.00(50.8)	

Reducing Union Tees

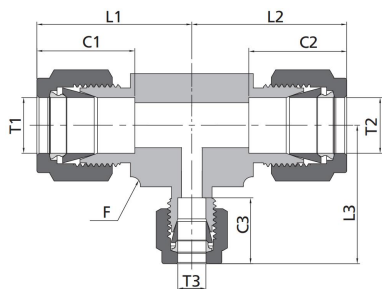

Metric Tube											
T1- O.D. (mm)	T2- O.D. (mm)	T3- O.D. (mm)	Basic Ordering Number	Dimension, mm (in.)							
				L1	L2	L3	C1	C2	C3	F	
3	3	6	-RUT-MT3-MT3-MT6	24.7(0.97)	24.7(0.97)	27.0(1.06)	12.9(0.51)	12.9(0.51)	15.3(0.60)	12.7(0.50)	
6	6	3	-RUT-MT6-MT6-MT3	27.0(1.06)	27.0(1.06)	25.4(1.00)	15.3(0.60)	15.3(0.60)	12.9(0.51)	12.7(0.50)	
6	6	8	-RUT-MT6-MT6-MT8	28.0(1.10)	28.0(1.10)	28.8(1.13)	15.3(0.60)	15.3(0.60)	16.2(0.64)	14.3(0.56)	
8	8	6	-RUT-MT8-MT8-MT6	30.0(1.18)	30.0(1.18)	29.0(1.14)	16.2(0.64)	16.2(0.64)	15.3(0.60)	15.9(0.63)	
8	8	12	-RUT-MT8-MT8-MT12	35.2(1.39)	35.2(1.39)	36.0(1.42)	16.2(0.64)	16.2(0.64)	22.8(0.90)	20.6(0.81)	
10	10	6	-RUT-MT10-MT10-MT6	31.5(1.24)	31.5(1.24)	29.9(1.18)	17.2(0.68)	17.2(0.68)	15.3(0.60)	17.5(0.69)	
10	10	8	-RUT-MT10-MT10-MT8	31.5(1.24)	31.5(1.24)	30.7(1.21)	17.2(0.68)	17.2(0.68)	16.2(0.64)	17.5(0.69)	
12	12	6	-RUT-MT12-MT12-MT6	36.0(1.42)	36.0(1.42)	31.8(1.25)	22.8(0.90)	22.8(0.90)	15.3(0.60)	20.6(0.81)	
12	12	8	-RUT-MT12-MT12-MT8	36.0(1.42)	36.0(1.42)	35.2(1.39)	22.8(0.90)	22.8(0.90)	16.2(0.64)	20.6(0.81)	
12	12	14	-RUT-MT12-MT12-MT14	38.0(1.50)	38.0(1.50)	38.0(1.50)	22.8(0.90)	22.8(0.90)	24.4(0.96)	25.4(1.00)	
12	12	18	-RUT-MT12-MT12-MT18	39.8(1.57)	39.8(1.57)	39.8(1.57)	22.8(0.90)	22.8(0.90)	24.4(0.96)	27.0(1.06)	
14	14	8	-RUT-MT14-MT14-MT8	38.0(1.50)	38.0(1.50)	37.2(1.46)	24.4(0.96)	24.4(0.96)	16.2(0.64)	25.4(1.00)	
14	14	10	-RUT-MT14-MT14-MT10	38.0(1.50)	38.0(1.50)	38.0(1.50)	24.4(0.96)	24.4(0.96)	17.2(0.68)	25.4(1.00)	
15	15	12	-RUT-MT15-MT15-MT12	38.8(1.53)	38.8(1.53)	38.8(1.53)	24.4(0.96)	24.4(0.96)	22.8(0.90)	25.4(1.00)	
16	8	16	-RUT-MT16-MT8-MT16	38.8(1.53)	37.2(1.46)	38.8(1.53)	24.4(0.96)	16.2(0.64)	24.4(0.96)	25.4(1.00)	
16	16	12	-RUT-MT16-MT16-MT12	38.8(1.53)	38.8(1.53)	38.9(1.53)	24.4(0.96)	24.4(0.96)	22.8(0.90)	25.4(1.00)	
18	18	8	-RUT-MT18-MT18-MT8	39.8(1.57)	39.8(1.57)	39.0(1.54)	24.4(0.96)	24.4(0.96)	16.2(0.64)	27.0(1.06)	
18	18	10	-RUT-MT18-MT18-MT10	39.8(1.57)	39.8(1.57)	39.8(1.57)	24.4(0.96)	24.4(0.96)	17.2(0.68)	27.0(1.06)	
18	18	12	-RUT-MT18-MT18-MT12	39.8(1.57)	39.8(1.57)	39.8(1.57)	24.4(0.96)	24.4(0.96)	22.8(0.90)	27.0(1.06)	
18	18	14	-RUT-MT18-MT18-MT14	39.8(1.57)	39.8(1.57)	39.8(1.57)	24.4(0.96)	24.4(0.96)	24.4(0.96)	27.0(1.06)	
20	20	14	-RUT-MT20-MT20-MT14	44.6(1.76)	44.6(1.76)	44.6(1.76)	26.0(1.02)	26.0(1.02)	24.4(0.96)	34.9(1.37)	
22	22	12	-RUT-MT22-MT22-MT12	44.6(1.76)	44.6(1.76)	44.6(1.76)	26.0(1.02)	26.0(1.02)	22.8(0.90)	34.9(1.37)	
25	25	12	-RUT-MT25-MT25-MT12	49.1(1.93)	49.1(1.93)	44.7(1.76)	31.3(1.23)	31.3(1.23)	22.8(0.90)	34.9(1.37)	

Male Branch Tees

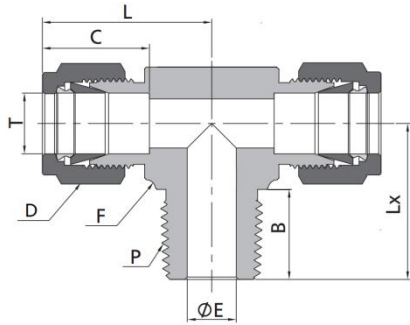

Fractional Tube to NPT Thread

T-Tube O.D.(in.)	P-NPT SIZE	Basic Ordering Number	Dimension,in(mm)						
			L	C	D	F	E	B	Lx
1/8	1/8	-MBT-FT2-MN2	0.93(23.6)	0.50(12.7)	0.44(11.1)	0.44(11.1)	0.09(2.3)	0.38(9.7)	0.70(17.8)
1/8	1/4	-MBT-FT2-MN4	0.97(24.6)	0.50(12.7)	0.44(11.1)	0.50(12.7)	0.09(2.3)	0.56(14.2)	0.92(23.4)
3/16	1/8	-MBT-FT3-MN2	0.96(24.4)	0.54(13.7)	0.50(12.7)	0.44(11.1)	0.12(3.0)	0.38(9.7)	0.70(17.8)
1/4	1/8	-MBT-FT4-MN2	1.06(26.9)	0.60(15.2)	0.56(14.3)	0.50(12.7)	0.19(4.8)	0.38(9.7)	0.74(18.8)
1/4	1/4	-MBT-FT4-MN4	1.06(26.9)	0.60(15.2)	0.56(14.3)	0.50(12.7)	0.19(4.8)	0.56(14.2)	0.92(23.4)
5/16	1/8	-MBT-FT5-MN2	1.17(29.7)	0.64(16.3)	0.63(15.9)	0.63(15.9)	0.19(4.8)	0.38(9.7)	0.82(20.8)
5/16	1/4	-MBT-FT5-MN4	1.17(29.7)	0.64(16.3)	0.63(15.9)	0.63(15.9)	0.25(6.4)	0.56(14.2)	1.01(25.7)
3/8	1/4	-MBT-FT6-MN4	1.20(30.5)	0.66(16.8)	0.69(17.5)	0.63(15.9)	0.28(7.1)	0.56(14.2)	1.00(25.4)
3/8	3/8	-MBT-FT6-MN6	1.31(33.3)	0.66(16.8)	0.69(17.5)	0.81(20.6)	0.28(7.1)	0.56(14.2)	1.11(28.2)
1/2	3/8	-MBT-FT8-MN6	1.42(36.1)	0.90(22.9)	0.87(22.2)	0.81(20.6)	0.38(9.7)	0.56(14.2)	1.11(28.2)
1/2	1/2	-MBT-FT8-MN8	1.42(36.1)	0.90(22.9)	0.87(22.2)	0.81(20.6)	0.41(10.4)	0.75(19.1)	1.30(33.0)
5/8	1/2	-MBT-FT10-MN8	1.53(38.9)	0.96(24.4)	1.00(25.4)	1.00(25.4)	0.47(11.9)	0.75(19.1)	1.41(35.8)
3/4	3/4	-MBT-FT12-MN12	1.57(39.9)	0.96(24.4)	1.13(28.6)	1.06(27.0)	0.62(15.7)	0.75(19.1)	1.45(36.8)
7/8	3/4	-MBT-FT14-MN12	1.76(44.7)	1.02(25.9)	1.25(31.8)	1.31(33.3)	0.62(15.7)	0.75(19.1)	1.50(38.1)
1	3/4	-MBT-FT16-MN12	1.94(49.3)	1.23(31.2)	1.50(38.1)	1.31(33.3)	0.62(15.7)	0.75(19.1)	1.67(42.4)
1	1	-MBT-FT16-MN16	1.94(49.3)	1.23(31.2)	1.50(38.1)	1.37(34.9)	0.88(22.4)	0.94(23.9)	1.84(46.7)

Metric Tube to NPT Thread

T-Tube O.D.(mm)	P-NPT SIZE	Basic Ordering Number	Dimension,mm(in)						
			L	C	D	F	E	B	Lx
6	1/8	-MBT-MT6-MN2	27.0(1.06)	15.3(0.60)	14.0(0.55)	12.7(0.50)	4.8(0.19)	9.7(0.38)	18.8(0.74)
6	1/4	-MBT-MT6-MN4	27.0(1.06)	15.3(0.60)	14.0(0.55)	12.7(0.50)	4.8(0.19)	14.2(0.56)	23.4(0.92)
8	1/8	-MBT-MT8-MN2	29.9(1.18)	16.2(0.64)	16.0(0.63)	15.9(0.63)	4.8(0.19)	9.7(0.38)	20.8(0.82)
8	1/4	-MBT-MT8-MN4	29.9(1.18)	16.2(0.64)	16.0(0.63)	15.9(0.63)	6.4(0.25)	14.2(0.56)	25.4(1.00)
10	1/4	-MBT-MT10-MN4	33.5(1.32)	17.2(0.68)	19.0(0.75)	20.6(0.81)	7.9(0.31)	14.2(0.56)	28.2(1.11)
10	3/8	-MBT-MT10-MN6	33.5(1.32)	17.2(0.68)	19.0(0.75)	20.6(0.81)	7.9(0.31)	14.2(0.56)	28.2(1.11)
12	1/4	-MBT-MT12-MN4	36.0(1.42)	22.8(0.90)	22.0(0.87)	20.6(0.81)	7.9(0.31)	14.2(0.56)	28.2(1.11)
12	3/8	-MBT-MT12-MN6	36.0(1.42)	22.8(0.90)	22.0(0.87)	20.6(0.81)	9.5(0.37)	14.2(0.56)	28.2(1.11)
12	1/2	-MBT-MT12-MN8	36.0(1.42)	22.8(0.90)	22.0(0.87)	20.6(0.81)	9.5(0.37)	19.1(0.75)	33.0(1.30)
16	1/2	-MBT-MT16-MN8	38.8(1.53)	24.4(0.96)	25.0(0.98)	25.4(1.00)	11.9(0.47)	19.1(0.75)	35.8(1.41)

Male Run Tees

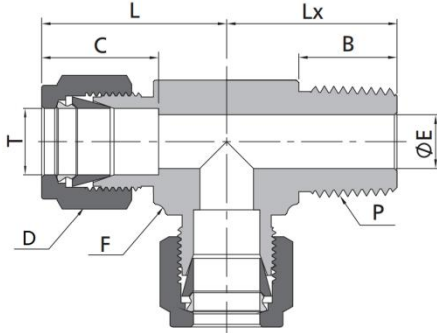

Fractional Tube to NPT Thread

T-Tube O.D.(in.)	P-NPT SIZE	Basic Ordering Number	Dimension,in(mm)						
			L	C	D	F	E	B	Lx
1/8	1/8	-MRT-FT2-MN2	0.93(23.6)	0.50(12.7)	0.44(11.1)	0.44(11.1)	0.09(2.3)	0.38(9.7)	0.70(17.8)
1/8	1/4	-MRT-FT2-MN4	0.97(24.6)	0.50(12.7)	0.44(11.1)	0.50(12.7)	0.09(2.3)	0.56(14.2)	0.92(23.4)
3/16	1/8	-MRT-FT3-MN2	0.96(24.4)	0.54(13.7)	0.50(12.7)	0.44(11.1)	0.12(3.0)	0.38(9.7)	0.70(17.8)
1/4	1/8	-MRT-FT4-MN2	1.06(26.9)	0.60(15.2)	0.56(14.3)	0.50(12.7)	0.19(4.8)	0.38(9.7)	0.74(18.8)
1/4	1/4	-MRT-FT4-MN4	1.06(26.9)	0.60(15.2)	0.56(14.3)	0.50(12.7)	0.19(4.8)	0.56(14.2)	0.92(23.4)
5/16	1/8	-MRT-FT5-MN2	1.17(29.7)	0.64(16.3)	0.63(15.9)	0.63(15.9)	0.19(4.8)	0.38(9.7)	0.82(20.8)
5/16	1/4	-MRT-FT5-MN4	1.17(29.7)	0.64(16.3)	0.63(15.9)	0.63(15.9)	0.25(6.4)	0.56(14.2)	1.01(25.7)
3/8	1/4	-MRT-FT6-MN4	1.20(30.5)	0.66(16.8)	0.69(17.5)	0.63(15.9)	0.28(7.1)	0.56(14.2)	1.00(25.4)
3/8	3/8	-MRT-FT6-MN6	1.31(33.3)	0.66(16.8)	0.69(17.5)	0.81(20.6)	0.28(7.1)	0.56(14.2)	1.11(28.2)
1/2	3/8	-MRT-FT8-MN6	1.42(36.1)	0.90(22.9)	0.87(22.2)	0.81(20.6)	0.38(9.7)	0.56(14.2)	1.11(28.2)
1/2	1/2	-MRT-FT8-MN8	1.42(36.1)	0.90(22.9)	0.87(22.2)	0.81(20.6)	0.41(10.4)	0.75(19.1)	1.3(33.0)
5/8	1/2	-MRT-FT10-MN8	1.50(38.1)	0.96(24.4)	1.00(25.4)	0.94(23.8)	0.47(11.9)	0.75(19.1)	1.41(35.8)
3/4	3/4	-MRT-FT12-MN12	1.57(39.9)	0.96(24.4)	1.13(28.6)	1.06(27.0)	0.62(15.7)	0.75(19.1)	1.45(36.8)
7/8	3/4	-MRT-FT14-MN12	1.76(44.7)	1.02(25.9)	1.25(31.8)	1.31(33.3)	0.62(15.7)	0.75(19.1)	1.50(38.1)
1	3/4	-MRT-FT16-MN12	1.94(49.3)	1.23(31.2)	1.50(38.1)	1.31(33.3)	0.62(15.7)	0.75(19.1)	1.67(42.4)
1	1	-MRT-FT16-MN16	1.94(49.3)	1.23(31.2)	1.50(38.1)	1.37(34.9)	0.88(22.4)	0.94(23.9)	1.84(46.7)

Metric Tube to NPT Thread

T-Tube O.D.(mm)	P-NPT SIZE	Basic Ordering Number	Dimension,mm(in)						
			L	C	D	F	E	B	Lx
6	1/8	-MRT-MT6-MN2	27.0(1.06)	15.3(0.60)	14.0(0.55)	12.7(0.50)	4.8(0.19)	9.7(0.38)	18.0(0.71)
6	1/4	-MRT-MT6-MN4	27.0(1.06)	15.3(0.60)	14.0(0.55)	12.7(0.50)	4.8(0.19)	14.2(0.56)	23.4(0.92)
8	1/8	-MRT-MT8-MN2	29.9(1.18)	16.2(0.64)	16.0(0.63)	15.9(0.63)	4.8(0.19)	9.7(0.38)	20.8(0.82)
8	1/4	-MRT-MT8-MN4	29.9(1.18)	16.2(0.64)	16.0(0.63)	15.9(0.63)	6.4(0.25)	14.2(0.56)	25.4(1.00)
10	1/4	-MRT-MT10-MN4	33.5(1.32)	17.2(0.68)	19.0(0.75)	20.6(0.81)	7.9(0.31)	14.2(0.56)	28.2(1.11)
10	1/2	-MRT-MT10-MN8	33.5(1.32)	17.2(0.68)	19.0(0.75)	20.6(0.81)	7.9(0.31)	14.2(0.56)	28.2(1.11)
12	1/4	-MRT-MT12-MN4	36.0(1.42)	22.8(0.90)	22.0(0.87)	20.6(0.81)	7.9(0.31)	14.2(0.56)	28.2(1.11)
12	3/8	-MRT-MT12-MN6	36.0(1.42)	22.8(0.90)	22.0(0.87)	20.6(0.81)	9.5(0.37)	14.2(0.56)	28.2(1.11)
12	1/2	-MRT-MT12-MN8	36.0(1.42)	22.8(0.90)	22.0(0.87)	20.6(0.81)	9.5(0.37)	19.1(0.75)	33.0(1.30)
16	1/2	-MRT-MT16-MN8	38.0(1.50)	24.4(0.96)	25.0(0.98)	23.8(0.94)	11.9(0.47)	19.1(0.75)	35.0(1.38)

Adjustable Male Branch Tees

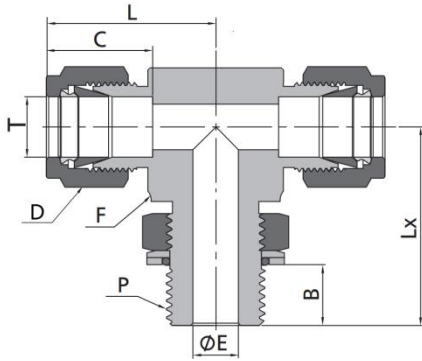

Fractional Tube to ISO Parallel Thread

T-Tube O.D.(in.)	P-BSP SIZE	Basic Ordering Number	Dimension,in(mm)						
			L	B	C	E	D	F	Lx
1/4	1/8	-AMB-FT4-PP2	1.06(26.9)	0.32(8.1)	0.60(15.2)	0.16(4.1)	0.56(14.3)	0.50(12.7)	1.04(26.4)
1/4	1/4	-AMB-FT4-PP4	1.14(29.0)	0.36(9.1)	0.60(15.2)	0.19(4.8)	0.56(14.3)	0.63(15.9)	1.27(32.3)
3/8	1/4	-AMB-FT6-PP4	1.20(30.5)	0.36(9.1)	0.66(16.8)	0.23(5.8)	0.69(17.5)	0.63(15.9)	1.27(32.3)
1/2	3/8	-AMB-FT8-PP6	1.42(36.1)	0.37(9.4)	0.90(22.9)	0.31(7.9)	0.87(22.2)	0.81(20.6)	1.46(37.1)
1/2	1/2	-AMB-FT8-PP8	1.50(38.1)	0.51(13.0)	0.90(22.9)	0.41(10.4)	0.87(22.2)	0.94(23.8)	1.71(43.4)
5/8	1/2	-AMB-FT10-PP8	1.50(38.1)	0.51(13.0)	0.96(24.4)	0.47(11.9)	1.00(25.4)	0.94(23.8)	1.71(43.4)
3/4	1/2	-AMB-FT12-PP8	1.57(39.9)	0.51(13.0)	0.96(24.4)	0.47(11.9)	1.13(28.6)	1.06(27.0)	1.78(45.2)
3/4	3/4	-AMB-FT12-PP12	1.57(39.9)	0.51(13.0)	0.96(24.4)	0.62(15.7)	1.13(28.6)	1.06(27.0)	1.92(48.8)
1	1	-AMB-FT16-PP16	1.93(49.0)	0.55(14.0)	1.23(31.2)	0.78(19.8)	1.50(38.1)	1.37(34.9)	2.11(53.6)

Fractional Tube to SAE/MS Thread

T-Tube O.D.(in.)	P-SAE/MS SIZE	Basic Ordering Number	Dimension,in(mm)						
			L	B	C	E	D	F	Lx
1/4	7/16-20	-AMB-FT4-ST7	1.12(28.5)	0.39(9.9)	0.60(15.2)	0.19(4.8)	0.56(14.3)	0.50(12.7)	1.12(28.5)
3/8	9/16-18	-AMB-FT6-ST9	1.26(32.0)	0.44(11.2)	0.66(16.8)	0.28(7.1)	0.69(17.5)	0.63(15.9)	1.27(32.3)
1/2	3/4-16	-AMB-FT8-ST12	1.48(37.6)	0.50(12.7)	0.90(22.9)	0.41(10.4)	0.87(22.2)	0.81(20.6)	1.49(37.8)
3/4	1 1/16-12	-AMB-FT12-ST17	1.63(41.4)	0.66(16.8)	0.96(24.4)	0.62(15.7)	1.13(28.6)	1.06(27.0)	1.92(48.8)
1	1 5/16-12	-AMB-FT16-ST21	1.99(50.5)	0.66(16.8)	1.23(31.2)	0.88(22.4)	1.50(38.1)	1.37(34.9)	2.11(53.6)
1 1/4	1 5/8-12	-AMB-FT20-ST26	2.67(67.8)	0.66(16.8)	1.62(41.1)	1.09(27.7)	1.87(47.6)	1.69(42.9)	2.29(58.2)
1 1/2	1 7/8-12	-AMB-FT24-ST30	3.07(78.0)	0.66(16.8)	1.97(50.0)	1.34(34.0)	2.25(57.2)	2.00(50.8)	2.38(60.5)

Metric Tube to ISO Parallel Thread

T-Tube O.D.(mm)	P-BSP SIZE	Basic Ordering Number	Dimension,mm(in)						
			L	B	C	E	D	F	Lx
6	1/8	-AMB-MT6-PP2	27.0(1.06)	8.1(0.32)	15.3(0.60)	4.0(0.16)	14.0(0.55)	12.7(0.50)	26.4(1.04)
6	1/4	-AMB-MT6-PP4	29.0(1.14)	9.1(0.36)	15.3(0.60)	4.8(0.19)	14.0(0.55)	15.9(0.63)	32.2(1.27)
8	1/8	-AMB-MT8-PP2	28.8(1.13)	8.1(0.32)	16.2(0.64)	4.0(0.16)	16.0(0.63)	14.3(0.56)	27.5(1.08)
8	1/4	-AMB-MT8-PP4	29.9(1.18)	9.1(0.36)	16.2(0.64)	5.9(0.23)	16.0(0.63)	15.9(0.63)	32.2(1.27)
10	1/4	-AMB-MT10-PP4	33.5(1.32)	9.1(0.36)	17.2(0.68)	5.9(0.23)	19.0(0.75)	20.6(0.81)	35.1(1.38)
12	3/8	-AMB-MT12-PP6	36.0(1.42)	9.4(0.37)	22.8(0.90)	7.9(0.31)	22.0(0.87)	20.6(0.81)	37.1(1.46)
12	1/2	-AMB-MT12-PP8	38.0(1.50)	13.0(0.51)	22.8(0.90)	9.5(0.37)	22.0(0.87)	23.8(0.94)	43.5(1.71)

Adjustable Male Run Tees

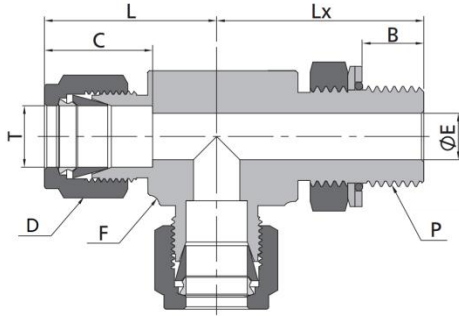

Fractional Tube to ISO Parallel Thread

T-Tube O.D.(in.)	P-BSP SIZE	Basic Ordering Number	Dimension,in(mm)						
			L	B	C	E	D	F	Lx
1/4	1/8	-AMR-FT4-PP2	1.06(26.9)	0.32(8.1)	0.60(15.2)	0.16(4.1)	0.56(14.3)	0.50(12.7)	1.04(26.4)
1/4	1/4	-AMR-FT4-PP4	1.14(29.0)	0.36(9.1)	0.60(15.2)	0.19(4.8)	0.56(14.3)	0.63(15.9)	1.27(32.3)
3/8	1/4	-AMR-FT6-PP4	1.20(30.5)	0.36(9.1)	0.66(16.8)	0.23(5.8)	0.69(17.5)	0.63(15.9)	1.27(32.3)
1/2	3/8	-AMR-FT8-PP6	1.42(36.1)	0.37(9.4)	0.90(22.9)	0.31(7.9)	0.87(22.2)	0.81(20.6)	1.46(37.1)
1/2	1/2	-AMR-FT8-PP8	1.50(38.1)	0.51(13.0)	0.90(22.9)	0.41(10.4)	0.87(22.2)	0.94(23.8)	1.71(43.4)
5/8	1/2	-AMR-FT10-PP8	1.50(38.1)	0.51(13.0)	0.96(24.4)	0.47(11.9)	1.00(25.4)	0.94(23.8)	1.71(43.4)
3/4	1/2	-AMR-FT12-PP8	1.57(39.9)	0.51(13.0)	0.96(24.4)	0.47(11.9)	1.13(28.6)	1.06(27.0)	1.78(45.2)
3/4	3/4	-AMR-FT12-PP12	1.57(39.9)	0.51(13.0)	0.96(24.4)	0.62(15.7)	1.13(28.6)	1.06(27.0)	1.92(48.8)
1	1	-AMR-FT16-PP16	1.93(49.0)	0.55(14.0)	1.23(31.2)	0.78(19.8)	1.50(38.1)	1.37(34.9)	2.11(53.6)

Fractional Tube to SAE/MS Thread

T-Tube O.D.(in.)	P-SAE/MS SIZE	Basic Ordering Number	Dimension,in(mm)						
			L	B	C	E	D	F	Lx
1/4	7/16-20	-AMR-FT4-ST7	1.12(28.5)	0.39(9.9)	0.60(15.2)	0.19(4.8)	0.56(14.3)	0.50(12.7)	1.12(28.5)
3/8	9/16-18	-AMR-FT6-ST9	1.26(32.0)	0.44(11.2)	0.66(16.8)	0.28(7.1)	0.69(17.5)	0.63(15.9)	1.27(32.3)
1/2	3/4-16	-AMR-FT8-ST12	1.48(37.6)	0.50(12.7)	0.90(22.9)	0.41(10.4)	0.87(22.2)	0.81(20.6)	1.49(37.8)
3/4	1 1/16-12	-AMR-FT12-ST17	1.63(41.4)	0.66(16.8)	0.96(24.4)	0.62(15.7)	1.13(28.6)	1.06(27.0)	1.92(48.8)
1	1 5/16-12	-AMR-FT16-ST21	1.99(50.5)	0.66(16.8)	1.23(31.2)	0.88(22.4)	1.50(38.1)	1.37(34.9)	2.11(53.6)
1 1/4	1 5/8-12	-AMR-FT20-ST26	2.67(67.8)	0.66(16.8)	1.62(41.1)	1.09(27.7)	1.87(47.6)	1.69(42.9)	2.29(58.2)
1 1/2	1 7/8-12	-AMR-FT24-ST30	3.07(78.0)	0.66(16.8)	1.97(50.0)	1.34(34.0)	2.25(57.2)	2.00(50.8)	2.38(60.5)

Metric Tube to ISO Parallel Thread

T-Tube O.D.(mm)	P-BSP SIZE	Basic Ordering Number	Dimension,mm(in)						
			L	B	C	E	D	F	Lx
6	1/8	-AMR-MT6-PP2	27.0(1.06)	8.1(0.32)	15.3(0.60)	4.0(0.16)	14.0(0.55)	12.7(0.50)	26.4(1.04)
6	1/4	-AMR-MT4-PP4	29.0(1.14)	9.1(0.36)	15.3(0.60)	4.8(0.19)	14.0(0.55)	15.9(0.63)	32.2(1.27)
8	1/8	-AMR-MT8-PP4	28.8(1.13)	8.1(0.32)	16.2(0.64)	4.0(0.16)	16.0(0.63)	14.3(0.56)	27.5(1.08)
8	1/4	-AMR-MT8-PP6	29.9(1.18)	9.1(0.36)	16.2(0.64)	5.9(0.23)	16.0(0.63)	15.9(0.63)	32.2(1.27)
10	1/4	-AMR-MT10-PP8	33.5(1.32)	9.1(0.36)	17.2(0.68)	5.9(0.23)	19.0(0.75)	20.6(0.81)	35.1(1.38)
12	3/8	-AMR-MT12-PP8	36.0(1.42)	9.4(0.37)	22.8(0.90)	7.9(0.31)	22.0(0.87)	20.6(0.81)	37.1(1.46)
12	1/2	-AMR-MT12-PP8	38.0(1.50)	13.0(0.51)	22.8(0.90)	9.5(0.37)	22.0(0.87)	23.8(0.94)	43.5(1.71)

Female Branch Tees

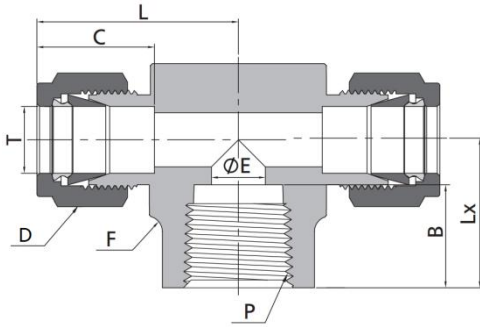

Fractional Tube to NPT Thread

T-Tube O.D.(in.)	P-NPT SIZE	Basic Ordering Number	Dimension,in(mm)						
			L	C	D	F	E	B	Lx
1/8	1/8	-FBT-FT2-FN2	0.97(24.6)	0.50(12.7)	0.44(11.1)	0.50(12.7)	0.09(2.3)	0.41(10.4)	0.75(19.1)
3/16	1/8	-FBT-FT3-FN2	1.01(25.7)	0.54(13.7)	0.50(12.7)	0.50(12.7)	0.12(3.0)	0.41(10.4)	0.75(19.1)
1/4	1/8	-FBT-FT4-FN2	1.06(26.9)	0.60(15.2)	0.56(14.3)	0.50(12.7)	0.19(4.8)	0.41(10.4)	0.75(19.1)
1/4	1/4	-FBT-FT4-FN4	1.17(29.7)	0.60(15.2)	0.56(14.3)	0.69(17.5)	0.19(4.8)	0.59(15.0)	0.88(22.4)
5/16	1/8	-FBT-FT5-FN2	1.17(29.7)	0.64(16.2)	0.63(15.9)	0.63(15.9)	0.25(6.4)	0.41(10.4)	0.75(19.1)
3/8	1/4	-FBT-FT6-FN4	1.23(31.2)	0.66(16.8)	0.69(17.5)	0.69(17.5)	0.28(7.1)	0.59(15.0)	0.88(22.4)
3/8	3/8	-FBT-FT6-FN6	1.31(33.3)	0.66(16.8)	0.69(17.5)	0.81(20.6)	0.28(7.1)	0.59(15.0)	0.88(22.4)
3/8	1/2	-FBT-FT6-FN8	1.42(36.1)	0.66(16.8)	0.69(17.5)	1.00(25.4)	0.28(7.1)	0.78(19.8)	1.12(28.4)
1/2	1/4	-FBT-FT8-FN4	1.42(36.1)	0.90(22.9)	0.87(22.2)	0.81(20.6)	0.41(10.4)	0.59(15.0)	0.88(22.4)
1/2	3/8	-FBT-FT8-FN6	1.42(36.1)	0.90(22.9)	0.87(22.2)	0.81(20.6)	0.41(10.4)	0.59(15.0)	0.88(22.4)
1/2	1/2	-FBT-FT8-FN8	1.53(38.9)	0.90(22.9)	0.87(22.2)	1.00(25.4)	0.41(10.4)	0.78(19.8)	1.12(28.4)
5/8	1/2	-FBT-FT10-FN8	1.53(38.9)	0.96(24.4)	1.00(25.4)	1.00(25.4)	0.50(12.7)	0.78(19.8)	1.12(28.4)
3/4	3/4	-FBT-FT12-FN12	1.76(44.7)	0.96(24.4)	1.13(28.6)	1.37(34.9)	0.62(15.7)	0.81(20.6)	1.25(31.8)
7/8	3/4	-FBT-FT14-FN12	1.76(44.7)	1.02(25.9)	1.25(31.8)	1.37(34.9)	0.72(18.3)	0.81(20.6)	1.25(31.8)
1	3/4	-FBT-FT16-FN12	1.93(49.0)	1.23(31.2)	1.50(38.1)	1.37(34.9)	0.88(22.4)	0.81(20.6)	1.25(31.8)
1	1	-FBT-FT16-FN16	2.11(53.6)	1.23(31.2)	1.50(38.1)	1.69(42.9)	0.88(22.4)	1.00(25.4)	1.50(38.1)

Metric Tube to NPT Thread

T-Tube O.D.(mm)	P-NPT SIZE	Basic Ordering Number	Dimension,mm(in)						
			L	C	D	F	E	B	Lx
6	1/8	-FBT-MT6-FN2	27.0(1.06)	15.3(0.60)	14.0(0.55)	12.7(0.50)	4.8(0.19)	10.4(0.41)	19.0(0.75)
6	1/4	-FBT-MT6-FN4	29.8(1.17)	15.3(0.60)	14.0(0.55)	17.5(0.69)	4.8(0.19)	15.0(0.59)	22.4(0.88)
8	1/8	-FBT-MT8-FN2	29.9(1.18)	16.2(0.64)	16.0(0.63)	15.9(0.63)	6.4(0.25)	10.4(0.41)	19.0(0.75)
8	1/4	-FBT-MT8-FN4	30.6(1.2)	16.2(0.64)	16.0(0.63)	17.5(0.69)	6.4(0.25)	15.0(0.59)	22.4(0.88)
10	1/4	-FBT-MT10-FN4	33.5(1.32)	17.2(0.68)	19.0(0.75)	20.6(0.81)	7.9(0.31)	15.0(0.59)	22.4(0.88)
12	1/8	-FBT-MT10-FN2	36.0(1.42)	22.8(0.90)	22.0(0.87)	20.6(0.81)	6.4(0.25)	10.4(0.41)	22.3(0.88)
12	1/4	-FBT-MT12-FN4	36.0(1.42)	22.8(0.90)	22.0(0.87)	20.6(0.81)	9.5(0.37)	15.0(0.59)	22.4(0.88)
12	3/8	-FBT-MT12-FN6	36.0(1.42)	22.8(0.90)	22.0(0.87)	20.6(0.81)	9.5(0.37)	15.0(0.59)	22.4(0.88)
12	1/2	-FBT-MT12-FN8	38.8(1.53)	22.8(0.90)	22.0(0.87)	25.4(1.00)	9.5(0.37)	19.8(0.78)	28.5(1.12)
16	1/2	-FBT-MT16-FN8	38.8(1.53)	24.4(0.96)	25.0(0.98)	25.4(1.00)	12.7(0.50)	19.8(0.78)	28.4(1.12)

Female Run Tees

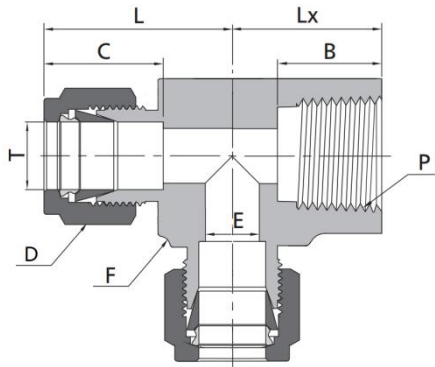

Fractional Tube to NPT Thread

T-Tube O.D.(in.)	P-NPT SIZE	Basic Ordering Number	Dimension,in(mm)						
			L	C	D	F	E	B	Lx
1/8	1/8	-FRT-FT2-FN2	0.97(24.6)	0.50(12.7)	0.44(11.1)	0.50(12.7)	0.09(2.3)	0.41(10.4)	0.75(19.1)
3/16	1/8	-FRT-FT3-FN2	1.01(25.7)	0.54(13.7)	0.50(12.7)	0.50(12.7)	0.12(3.0)	0.41(10.4)	0.75(19.1)
1/4	1/8	-FRT-FT4-FN2	1.06(26.9)	0.60(15.2)	0.56(14.3)	0.50(12.7)	0.19(4.8)	0.41(10.4)	0.75(19.1)
1/4	1/4	-FRT-FT4-FN4	1.17(29.7)	0.60(15.2)	0.56(14.3)	0.69(17.5)	0.19(4.8)	0.59(15.0)	0.88(22.4)
5/16	1/8	-FRT-FT5-FN2	1.17(29.7)	0.64(16.2)	0.63(15.9)	0.63(15.9)	0.25(6.4)	0.41(10.4)	0.75(19.1)
3/8	1/4	-FRT-FT6-FN4	1.23(31.2)	0.66(16.8)	0.69(17.5)	0.69(17.5)	0.28(7.1)	0.59(15.0)	0.88(22.4)
1/2	1/4	-FRT-FT8-FN4	1.42(36.1)	0.90(22.9)	0.87(22.2)	0.81(20.6)	0.41(10.4)	0.59(15.0)	0.88(22.4)
1/2	3/8	-FRT-FT8-FN6	1.42(36.1)	0.90(22.9)	0.87(22.2)	0.81(20.6)	0.41(10.4)	0.59(15.0)	0.88(22.4)
1/2	1/2	-FRT-FT8-FN8	1.57(39.9)	0.90(22.9)	0.87(22.2)	1.06(27.0)	0.41(10.4)	0.78(19.8)	1.12(28.4)
5/8	1/2	-FRT-FT10-FN8	1.57(39.9)	0.96(24.4)	1.00(25.4)	1.06(27.0)	0.50(12.7)	0.78(19.8)	1.12(28.4)
3/4	3/4	-FRT-FT12-FN12	1.76(44.7)	0.96(24.4)	1.13(28.6)	1.37(34.9)	0.62(15.7)	0.81(20.6)	1.25(31.8)
7/8	3/4	-FRT-FT14-FN8	1.76(44.7)	1.02(25.9)	1.25(31.8)	1.37(34.9)	0.62(15.7)	0.78(19.8)	1.12(28.4)
7/8	3/4	-FRT-FT14-FN12	1.76(44.7)	1.02(25.9)	1.25(31.8)	1.37(34.9)	0.72(18.3)	0.81(20.6)	1.25(31.8)
1	3/4	-FRT-FT16-FN12	1.93(49.0)	1.23(31.2)	1.50(38.1)	1.37(34.9)	0.88(22.4)	0.81(20.6)	1.25(31.8)
1	1	-FRT-FT16-FN16	2.11(53.6)	1.23(31.2)	1.50(38.1)	1.69(42.9)	0.88(22.4)	1.00(25.4)	1.50(38.1)

Metric Tube to NPT Thread

T-Tube O.D.(mm)	P-NPT SIZE	Basic Ordering Number	Dimension,mm(in)						
			L	C	D	F	E	B	Lx
6	1/8	-FRT-MT6-FN2	27.0(1.06)	15.3(0.60)	14.0(0.55)	12.7(0.50)	4.8(0.19)	10.4(0.41)	19.0(0.75)
6	1/4	-FRT-MT6-FN4	29.8(1.17)	15.3(0.60)	14.0(0.55)	17.5(0.69)	4.8(0.19)	15.0(0.59)	22.4(0.88)
8	1/8	-FRT-MT8-FN2	29.9(1.18)	16.2(0.64)	16.0(0.63)	15.9(0.63)	4.8(0.19)	10.4(0.41)	19.0(0.75)
8	1/4	-FRT-MT8-FN4	30.6(1.20)	16.2(0.64)	16.0(0.63)	17.5(0.69)	6.4(0.25)	15.0(0.59)	22.4(0.88)
10	1/4	-FRT-MT10-FN4	33.5(1.32)	17.2(0.68)	19.0(0.75)	20.6(0.81)	7.9(0.31)	15.0(0.59)	22.4(0.88)
12	1/4	-FRT-MT12-FN4	36.0(1.42)	22.8(0.90)	22.0(0.87)	20.6(0.81)	9.5(0.37)	15.0(0.59)	22.4(0.88)
12	3/8	-FRT-MT12-FN6	36.0(1.42)	22.8(0.90)	22.0(0.87)	20.6(0.81)	9.5(0.37)	15.0(0.59)	23.1(0.91)
12	1/2	-FRT-MT12-FN8	38.8(1.53)	22.8(0.90)	22.0(0.87)	25.4(1.00)	9.5(0.37)	19.8(0.78)	28.5(1.12)
16	1/2	-FRT-MT16-FN8	39.8(1.57)	24.4(0.96)	25.0(0.98)	27.0(1.06)	11.9(0.47)	19.8(0.78)	28.4(1.12)

Union Crosses

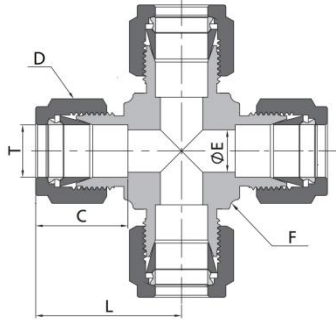

Fractional Tube						
T-Tube O.D.(in.)	Basic Ordering Number	Dimension, in. (mm)				
		L	C	D	F	E
1/8	-UC-FT2	0.88(22.4)	0.50(12.7)	0.44(11.1)	0.37(9.5)	0.09(2.3)
3/16	-UC-FT3	0.96(24.4)	0.54(13.7)	0.50(12.7)	0.44(11.1)	0.12(3.0)
1/4	-UC-FT4	1.06(26.9)	0.60(15.2)	0.56(14.3)	0.50(12.7)	0.19(4.8)
5/16	-UC-FT5	1.17(29.7)	0.64(16.2)	0.63(15.9)	0.63(15.9)	0.25(6.4)
3/8	-UC-FT6	1.20(30.5)	0.66(16.8)	0.69(17.5)	0.63(15.9)	0.28(7.1)
1/2	-UC-FT8	1.42(36.1)	0.90(22.9)	0.69(17.5)	0.81(20.6)	0.41(10.4)
5/8	-UC-FT10	1.43(36.3)	0.96(24.4)	1.00(25.4)	1.06(27.0)	0.50(12.7)
3/4	-UC-FT12	1.57(39.9)	0.96(24.4)	1.13(28.6)	1.06(27.0)	0.62(15.7)
7/8	-UC-FT14	1.76(44.7)	1.02(25.9)	1.25(31.8)	1.37(34.9)	0.72(18.3)
1	-UC-FT16	1.93(49.0)	1.23(31.2)	1.50(38.1)	1.37(34.9)	0.88(22.4)

Metric Tube						
T-Tube O.D.(mm)	Basic Ordering Number	Dimension,mm (in.)				
		L	C	D	F	E
3	-UC-MT3	22.3(0.88)	12.9(0.51)	12.0(0.47)	9.5(0.37)	2.4(0.09)
4	-UC-MT4	25.4(1.00)	13.7(0.54)	12.0(0.47)	12.7(0.50)	2.4(0.09)
6	-UC-MT6	27.0(1.06)	15.3(0.60)	14.0(0.55)	12.7(0.50)	4.8(0.19)
8	-UC-MT8	29.9(1.18)	16.2(0.64)	16.0(0.63)	15.9(0.63)	6.4(0.25)
10	-UC-MT10	33.5(1.32)	17.2(0.68)	19.0(0.75)	20.6(0.81)	7.9(0.31)
12	-UC-MT12	36.0(1.42)	22.8(0.90)	22.0(0.87)	20.6(0.81)	9.5(0.37)
16	-UC-MT16	37.0(1.46)	24.4(0.96)	25.0(0.98)	23.8(0.94)	12.7(0.50)
18	-UC-MT18	38.3(1.51)	24.4(0.96)	30.0(1.18)	27.0(1.06)	15.1(0.59)
20	-UC-MT20	44.6(1.76)	26.0(1.02)	32.0(1.26)	34.9(1.37)	15.9(0.63)
22	-UC-MT22	44.7(1.76)	26.0(1.02)	32.0(1.26)	34.9(1.37)	18.3(0.72)
25	-UC-MT25	49.2(1.94)	31.3(1.23)	38.0(1.50)	34.9(1.37)	21.8(0.86)

42 Tube Fittings

Caps

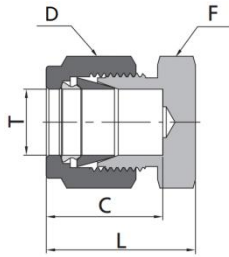

Fractional Tube

T-Tube O.D.(in.)	Basic Ordering Number	Dimension, in. (mm)			
		L	C	D	F
1/16	-TC-FT1	0.59(15.0)	0.34(8.6)	0.31(7.9)	0.31(7.9)
1/8	-TC-FT2	0.79(20.1)	0.50(12.7)	0.44(11.1)	0.44(11.1)
3/16	-TC-FT3	0.84(21.3)	0.54(13.7)	0.50(12.7)	0.44(11.1)
1/4	-TC-FT4	0.92(23.4)	0.60(15.2)	0.56(14.3)	0.50(12.7)
5/16	-TC-FT5	0.96(24.4)	0.64(16.3)	0.63(15.9)	0.56(14.3)
3/8	-TC-FT6	1.01(25.7)	0.66(16.8)	0.69(17.5)	0.63(15.9)
1/2	-TC-FT8	1.15(29.2)	0.90(22.9)	0.87(22.2)	0.81(20.6)
5/8	-TC-FT10	1.18(30.0)	0.96(24.4)	1.00(25.4)	0.94(23.8)
3/4	-TC-FT12	1.24(31.5)	0.96(24.4)	1.13(28.6)	1.06(27.0)
7/8	-TC-FT14	1.34(34.0)	1.02(25.9)	1.25(31.8)	1.19(30.2)
1	-TC-FT16	1.51(38.4)	1.23(31.2)	1.50(38.1)	1.37(34.9)
1 1/8	-TC-FT18	1.51(38.4)	1.23(31.2)	1.81(46.0)	1.63(41.3)
1 1/4	-TC-FT20	2.10(53.3)	1.62(41.1)	1.87(47.6)	1.75(44.5)
1 1/2	-TC-FL24	2.54(64.5)	1.97(50.0)	2.25(57.2)	2.13(54.0)

Metric Tube

T-Tube O.D.(mm)	Basic Ordering Number	Dimension,mm (in.)			
		L	C	D	F
2	-TC-MT2	20.1(0.79)	12.9(0.51)	12.0(0.47)	12.0(0.47)
3	-TC-MT3	20.1(0.79)	12.9(0.51)	12.0(0.47)	12.0(0.47)
4	-TC-MT4	21.3(0.84)	13.7(0.54)	12.0(0.47)	12.0(0.47)
6	-TC-MT6	23.1(0.91)	15.3(0.60)	14.0(0.55)	14.0(0.55)
8	-TC-MT8	24.5(0.96)	16.2(0.64)	16.0(0.63)	15.0(0.59)
10	-TC-MT10	26.6(1.05)	17.2(0.68)	19.0(0.75)	18.0(0.71)
12	-TC-MT12	29.1(1.15)	22.8(0.90)	22.0(0.87)	22.0(0.87)
14	-TC-MT14	29.9(1.18)	24.4(0.96)	22.0(0.87)	24.0(0.94)
15	-TC-MT15	29.9(1.18)	24.4(0.96)	25.0(0.98)	24.0(0.94)
16	-TC-MT16	29.9(1.18)	24.4(0.96)	25.0(0.98)	24.0(0.94)
18	-TC-MT18	31.4(1.24)	24.4(0.96)	30.0(1.18)	27.0(1.06)
20	-TC-MT20	34.0(1.34)	26.0(1.02)	32.0(1.26)	30.0(1.18)
22	-TC-MT22	34.0(1.34)	26.0(1.02)	32.0(1.26)	30.0(1.18)
25	-TC-MT25	38.5(1.52)	31.3(1.23)	38.0(1.50)	35.0(1.38)
28	-TC-MT28	48.5(1.91)	36.6(1.44)	46.0(1.81)	41.0(1.61)
30	-TC-MT30	53.4(2.10)	39.6(1.56)	50.0(1.97)	46.0(1.81)
32	-TC-MT32	55.8(2.20)	42.0(1.65)	50.0(1.97)	46.0(1.81)
38	-TC-MT38	65.4(2.57)	49.4(1.94)	60.0(2.36)	55.0(2.17)

Plugs

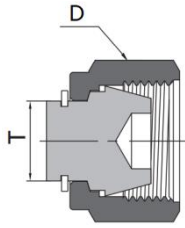

Fractional Tube		
T-Tube O.D.(in.)	Basic Ordering Number	Dimension, in. (mm)
		D
1/16	-TP-FT1	0.31(7.9)
1/8	-TP-FT2	0.44(11.1)
3/16	-TP-FT3	0.50(12.7)
1/4	-TP-FT4	0.56(14.3)
5/16	-TP-FT5	0.63(15.9)
3/8	-TP-FT6	0.69(17.5)
1/2	-TP-FT8	0.87(22.2)
5/8	-TP-FT10	1.00(25.4)
3/4	-TP-FT12	1.13(28.6)
7/8	-TP-FT14	1.25(31.8)
1	-TP-FT16	1.50(38.1)
1 1/4	-TP-FT20	1.87(47.6)
1 1/2	-TP-FT24	2.25(57.2)

Metric Tube		
T-Tube O.D.(mm)	Basic Ordering Number	Dimension, mm(In.)
		D
2	-TP-MT2	12.0(0.47)
3	-TP-MT3	12.0(0.47)
4	-TP-MT4	12.0(0.47)
6	-TP-MT6	14.0(0.55)
8	-TP-MT8	16.0(0.63)
10	-TP-MT10	19.0(0.75)
12	-TP-MT12	22.0(0.87)
14	-TP-MT14	25.0(0.98)
15	-TP-MT15	25.0(0.98)
16	-TP-MT16	25.0(0.98)
18	-TP-MT18	30.0(1.18)
20	-TP-MT20	32.0(1.26)
22	-TP-MT22	32.0(1.26)
25	-TP-MT25	38.0(1.50)
28	-TP-MT28	46.0(1.81)
30	-TP-MT30	50.0(1.97)
32	-TP-MT32	50.0(1.97)
38	-TP-MT38	60.0(2.36)

Reducers

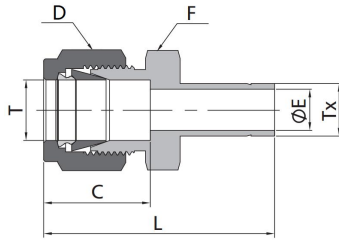

Fractional Tube							
T-Tube O.D.(in.)	Tx-Tube O.D.(in.)	Basic Ordering Number	Dimension, in. (mm)				
			L	C	D	F	E
1/16	1/8	-RD-FT1-FTD2	1.15(29.2)	0.34(8.6)	0.31(7.9)	0.31(7.9)	0.05(1.3)
1/16	3/16	-RD-FT1-FTD3	1.18(30.0)	0.34(8.6)	0.31(7.9)	0.31(7.9)	0.05(1.3)
1/16	1/4	-RD-FT1-FTD4	1.24(31.5)	0.34(8.6)	0.31(7.9)	0.31(7.9)	0.05(1.3)
1/8	1/16	-RD-FT2-FTD1	1.14(29.0)	0.50(12.7)	0.44(11.1)	0.44(11.1)	0.03(0.8)
1/8	1/8	-RD-FT2-FTD2	1.32(33.5)	0.50(12.7)	0.44(11.1)	0.44(11.1)	0.08(2.0)
1/8	3/16	-RD-FT2-FTD3	1.35(34.3)	0.50(12.7)	0.44(11.1)	0.44(11.1)	0.09(2.3)
1/8	1/4	-RD-FT2-FTD4	1.42(36.1)	0.50(12.7)	0.44(11.1)	0.44(11.1)	0.09(2.3)
1/8	3/8	-RD-FT2-FTD6	1.48(37.6)	0.50(12.7)	0.44(11.1)	0.44(11.1)	0.09(2.3)
1/8	1/2	-RD-FT2-FTD8	1.74(44.2)	0.50(12.7)	0.44(11.1)	0.56(14.3)	0.09(2.3)
3/16	1/8	-RD-FT3-FTD2	1.37(34.8)	0.54(13.7)	0.50(12.7)	0.44(11.1)	0.08(2.0)
3/16	1/4	-RD-FT3-FTD4	1.46(37.1)	0.54(13.7)	0.50(12.7)	0.44(11.1)	0.12(3.0)
1/4	1/8	-RD-FT4-FTD2	1.45(36.8)	0.60(15.2)	0.56(14.3)	0.50(12.7)	0.08(2.0)
1/4	3/16	-RD-FT4-FTD3	1.48(37.6)	0.60(15.2)	0.56(14.3)	0.50(12.7)	0.12(3.0)
1/4	1/4	-RD-FT4-FTD4	1.54(39.1)	0.60(15.2)	0.56(14.3)	0.50(12.7)	0.17(4.3)
1/4	5/16	-RD-FT4-FTD5	1.57(39.9)	0.60(15.2)	0.56(14.3)	0.50(12.7)	0.19(4.8)
1/4	3/8	-RD-FT4-FTD6	1.60(40.6)	0.60(15.2)	0.56(14.3)	0.50(12.7)	0.19(4.8)
1/4	1/2	-RD-FT4-FTD8	1.82(46.2)	0.60(15.2)	0.56(14.3)	0.56(14.3)	0.19(4.8)
1/4	5/8	-RD-FT4-FTD0	1.89(48.0)	0.60(15.2)	0.56(14.3)	0.69(17.5)	0.19(4.8)
1/4	3/4	-RD-FT4-FTD2	1.88(47.8)	0.60(15.2)	0.56(14.3)	0.81(20.6)	0.19(4.8)
5/6	3/8	-RD-FT5-FTD6	1.65(41.9)	0.64(16.3)	0.63(15.9)	0.56(14.3)	0.25(6.4)
5/16	1/2	-RD-FT5-FTD8	1.87(47.5)	0.64(16.3)	0.63(15.9)	0.56(14.3)	0.25(6.4)
3/8	1/4	-RD-FT6-FTD4	1.63(41.4)	0.66(16.8)	0.69(17.5)	0.63(15.9)	0.17(4.3)
3/8	3/8	-RD-FT6-FT6	1.70(43.2)	0.66(16.8)	0.69(17.5)	0.63(15.9)	0.27(6.9)
3/8	1/2	-RD-FT6-FTD8	1.91(48.5)	0.66(16.8)	0.69(17.5)	0.63(15.9)	0.28(7.1)
3/8	5/8	-RD-FT6-FTD0	1.98(50.3)	0.66(16.8)	0.69(17.5)	0.69(17.5)	0.28(7.1)
3/8	3/4	-RD-FT6-FTD2	1.98(50.3)	0.66(16.8)	0.69(17.5)	0.81(20.6)	0.28(7.1)
1/2	1/4	-RD-FT8-FTD4	1.77(45.0)	0.90(22.9)	0.87(22.2)	0.81(20.6)	0.17(4.3)
1/2	3/8	-RD-FT8-FTD6	1.84(46.7)	0.90(22.9)	0.87(22.2)	0.81(20.6)	0.27(6.9)
1/2	1/2	-RD-FT8-FTD8	2.06(52.3)	0.90(22.9)	0.87(22.2)	0.81(20.6)	0.37(9.4)
1/2	5/8	-RD-FT8-FTD0	2.12(53.8)	0.90(22.9)	0.87(22.2)	0.81(20.6)	0.41(10.4)
1/2	3/4	-RD-FT8-FTD2	2.12(53.8)	0.90(22.9)	0.87(22.2)	0.81(20.6)	0.41(10.4)
1/2	1	-RD-FT8-FTD6	2.37(60.2)	0.90(22.9)	0.87(22.2)	1.06(27.0)	0.41(10.4)
5/8	3/4	-RD-FT10-FTD2	2.15(54.6)	0.96(24.4)	1.00(25.4)	0.94(23.8)	0.50(12.7)
5/8	7/8	-RD-FT10-FTD14	2.21(56.1)	0.96(24.4)	1.00(25.4)	0.94(23.8)	0.50(12.7)
5/8	1	-RD-FT10-FTD16	2.40(61.0)	0.96(24.4)	1.00(25.4)	1.06(27.0)	0.50(12.7)
3/4	3/4	-RD-FT12-FTD12	2.15(54.6)	0.96(24.4)	1.13(28.6)	1.06(27.0)	0.58(14.7)
3/4	1	-RD-FT12-FTD16	2.46(62.5)	0.96(24.4)	1.13(28.6)	1.06(27.0)	0.62(15.7)
1	1 1/4	-RD-FT16-FTD20	3.17(80.5)	1.23(31.2)	1.50(38.1)	1.37(34.9)	0.88(22.4)
1	1 1/2	-RD-FT16-FTD24	3.51(89.2)	1.23(31.2)	1.50(38.1)	1.63(41.3)	0.88(22.4)
1	2	-RD-FT16-FTD32	4.43(112.5)	1.23(31.2)	1.50(38.1)	2.13(54.0)	0.96(24.4)
1 1/4	1 1/2	-RD-FT20-FTD24	4.10(104.1)	1.62(41.1)	2.25(57.2)	1.87(47.6)	1.09(27.7)

Reducers

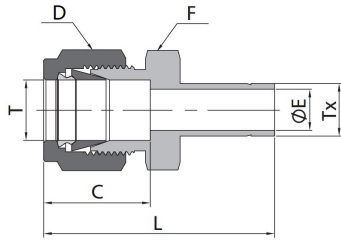

Metric Tube							
T-Tube O.D.(mm)	TX-Tube O.D.(mm)	Basic Ordering Number	Dimension,mm (in.)				
			L	C	D	F	E
2	3	-RD-MT2-MTD3	33.5(1.32)	12.9(0.51)	12.0(0.47)	12.0(0.47)	1.7(0.07)
3	4	-RD-MT3-MTD4	35.0(1.38)	12.9(0.51)	12.0(0.47)	12.0(0.47)	2.4(0.09)
3	6	-RD-MT3-MTD6	36.1(1.42)	12.9(0.51)	12.0(0.47)	12.0(0.47)	2.4(0.09)
3	10	-RD-MT3-MTD10	38.4(1.51)	12.9(0.51)	12.0(0.47)	14.0(0.55)	2.4(0.09)
4	6	-RD-MT4-MTD6	37.1(1.46)	13.7(0.54)	12.0(0.47)	12.0(0.47)	2.4(0.09)
6	3	-RD-MT6-MTD3	36.9(1.45)	15.3(0.60)	14.0(0.55)	14.0(0.55)	1.9(0.07)
6	8	-RD-MT6-MTD8	39.9(1.57)	15.3(0.60)	14.0(0.55)	14.0(0.55)	4.8(0.19)
6	10	-RD-MT6-MTD10	40.7(1.60)	15.3(0.60)	14.0(0.55)	14.0(0.55)	4.8(0.19)
6	12	-RD-MT6-MTD12	46.3(1.82)	15.3(0.60)	14.0(0.55)	14.0(0.55)	4.8(0.19)
6	18	-RD-MT6-MTD18	49.6(1.95)	15.3(0.60)	14.0(0.55)	22.0(0.87)	4.8(0.19)
8	6	-RD-MT8-MTD6	40.3(1.59)	16.2(0.64)	16.0(0.63)	15.0(0.59)	4.1(0.16)
8	10	-RD-MT8-MTD10	42.0(1.65)	16.2(0.64)	16.0(0.63)	15.0(0.59)	6.4(0.25)
8	12	-RD-MT8-MTD12	47.6(1.87)	16.2(0.64)	16.0(0.63)	15.0(0.59)	6.4(0.25)
10	6	-RD-MT10-MTD6	42.4(1.67)	17.2(0.68)	19.0(0.75)	18.0(0.71)	4.1(0.16)
10	8	-RD-MT10-MTD8	43.4(1.71)	17.2(0.68)	19.0(0.75)	18.0(0.71)	5.6(0.22)
10	12	-RD-MT10-MTD12	49.8(1.96)	17.2(0.68)	19.0(0.75)	18.0(0.71)	7.9(0.31)
10	15	-RD-MT10-MTD15	51.3(2.02)	17.2(0.68)	19.0(0.75)	18.0(0.71)	7.9(0.31)
10	18	-RD-MT2-MTD3	51.3(2.02)	17.2(0.68)	19.0(0.75)	22.0(0.87)	7.9(0.31)
12	6	-RD-MT12-MTD6	44.9(1.77)	22.8(0.90)	22.0(0.87)	22.0(0.87)	4.1(0.16)
12	8	-RD-MT12-MTD8	45.9(1.81)	22.8(0.90)	22.0(0.87)	22.0(0.87)	5.6(0.22)
12	10	-RD-MT12-MTD10	46.7(1.84)	22.8(0.90)	22.0(0.87)	22.0(0.87)	7.1(0.28)
12	16	-RD-MT12-MTD16	53.8(2.12)	22.8(0.90)	22.0(0.87)	22.0(0.87)	9.5(0.37)
12	18	-RD-MT12-MTD18	53.8(2.12)	22.8(0.90)	22.0(0.87)	22.0(0.87)	9.5(0.37)
12	20	-RD-MT12-MTD20	56.1(2.21)	22.8(0.90)	22.0(0.87)	22.0(0.87)	9.5(0.37)
12	22	-RD-MT12-MTD22	56.1(2.21)	22.8(0.90)	22.0(0.87)	24.0(0.94)	9.5(0.37)
12	25	-RD-MT12-MTD25	62.4(2.46)	22.8(0.90)	22.0(0.87)	27.0(1.06)	9.5(0.37)
16	12	-RD-MT16-MTD12	53.0(2.09)	24.4(0.96)	25.0(0.98)	24.0(0.94)	8.8(0.35)
18	12	-RD-MT18-MTD12	54.6(2.15)	24.4(0.96)	30.0(1.18)	27.0(1.06)	8.8(0.35)
18	16	-RD-MT18-MTD16	56.1(2.21)	24.4(0.96)	30.0(1.18)	27.0(1.06)	12.0(0.47)
18	20	-RD-MT18-MTD20	57.6(2.27)	24.4(0.96)	30.0(1.18)	27.0(1.06)	15.1(0.59)
18	22	-RD-MT18-MTD22	57.6(2.27)	24.4(0.96)	30.0(1.18)	27.0(1.06)	15.1(0.59)
18	25	-RD-MT18-MTD25	62.4(2.46)	24.4(0.96)	30.0(1.18)	27.0(1.06)	15.1(0.59)
20	16	-RD-MT20-MTD16	57.9(2.28)	26.0(1.02)	32.0(1.26)	30.0(1.18)	12.0(0.47)
20	18	-RD-MT20-MTD18	57.9(2.28)	26.0(1.02)	32.0(1.26)	30.0(1.18)	13.9(0.55)
20	22	-RD-MT20-MTD22	59.4(2.34)	26.0(1.02)	32.0(1.26)	30.0(1.18)	15.9(0.63)
20	25	-RD-MT20-MTD25	64.2(2.53)	26.0(1.02)	32.0(1.26)	30.0(1.18)	15.8(0.62)
22	18	-RD-MT22-MTD18	57.9(2.28)	26.0(1.02)	32.0(1.26)	30.0(1.18)	13.9(0.55)
22	20	-RD-MT22-MTD20	59.4(2.34)	26.0(1.02)	32.0(1.26)	30.0(1.18)	15.5(0.61)
22	25	-RD-MT22-MTD25	64.2(2.53)	26.0(1.02)	32.0(1.26)	30.0(1.18)	18.3(0.72)
25	18	-RD-MT25-MTD18	63.1(2.48)	31.3(1.23)	38.0(1.50)	35.0(1.38)	13.9(0.55)
25	20	-RD-MT25-MTD20	64.6(2.54)	31.3(1.23)	38.0(1.50)	35.0(1.38)	15.5(0.61)

Reducers

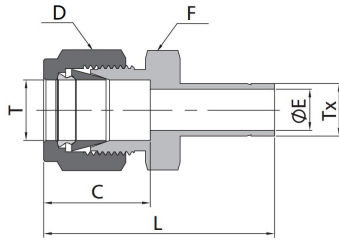

Metric Tube to Fractional Tube

T-Tube O.D.(mm)	TX-Tube O.D.(in.)	Basic Ordering Number	Dimension, in.(mm.)				
			L	C	D	F	E
2	1/8	-RD-MT2-FTD2	33.5(1.32)	12.9(0.51)	12.0(0.47)	12.0(0.47)	1.7(0.07)
3	1/8	-RD-MT3-FTD2	33.5(1.32)	12.9(0.51)	12.0(0.47)	12.0(0.47)	2.0(0.08)
3	1/4	-RD-MT3-FTD4	36.1(1.42)	12.9(0.51)	12.0(0.47)	12.0(0.47)	2.4(0.09)
4	1/4	-RD-MT4-FTD4	37.1(1.46)	13.7(0.54)	12.0(0.47)	12.0(0.47)	2.4(0.09)
6	1/8	-RD-MT6-FTD2	36.9(1.45)	15.3(0.60)	14.0(0.55)	14.0(0.55)	2.0(0.08)
6	1/4	-RD-MT6-FTD4	39.2(1.54)	15.3(0.60)	14.0(0.55)	14.0(0.55)	4.4(0.17)
6	5/16	-RD-MT6-FTD5	39.9(1.57)	15.3(0.60)	14.0(0.55)	14.0(0.55)	4.8(0.19)
6	3/8	-RD-MT6-FTD6	40.7(1.60)	15.3(0.60)	14.0(0.55)	14.0(0.55)	4.8(0.19)
6	1/2	-RD-MT6-FTD8	46.3(1.82)	15.3(0.60)	14.0(0.55)	14.0(0.55)	4.8(0.19)
8	1/4	-RD-MT8-FTD4	40.3(1.59)	16.2(0.64)	16.0(0.63)	15.0(0.59)	4.4(0.17)
8	3/8	-RD-MT8-FTD6	42.0(1.65)	16.2(0.64)	16.0(0.63)	15.0(0.59)	6.4(0.25)
8	1/2	-RD-MT8-FTD8	47.6(1.87)	16.2(0.64)	16.0(0.63)	15.0(0.59)	6.4(0.25)
10	3/8	-RD-MT10-FTD6	44.4(1.75)	17.2(0.68)	19.0(0.75)	18.0(0.71)	6.8(0.27)
10	1/2	-RD-MT10-FTD8	49.8(1.96)	17.2(0.68)	19.0(0.75)	18.0(0.71)	7.9(0.31)
12	1/2	-RD-MT12-FTD8	52.3(2.06)	22.8(0.90)	22.0(0.87)	22.0(0.87)	9.3(0.37)
12	3/4	-RD-MT12-FTD12	53.8(2.12)	22.8(0.90)	22.0(0.87)	22.0(0.87)	9.5(0.37)
18	3/4	-RD-MT18-FTD12	56.1(2.21)	24.4(0.96)	30.0(1.18)	27.0(1.06)	14.7(0.58)
18	1	-RD-MT18-FTD16	62.4(2.46)	24.4(0.96)	30.0(1.18)	27.0(1.06)	15.1(0.59)
25	1	-RD-MT25-FTD16	69.5(2.74)	31.3(1.23)	38.0(1.50)	35.0(1.38)	20.2(0.80)

Bulkhead Reducers

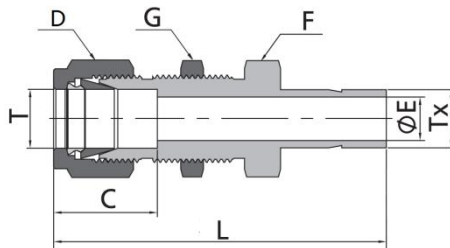

Fractional Tube

T-Tube O.D.(in.)	Tx-Tube O.D.(in.)	Basic Ordering Number	Dimension, in. (mm)						
			L	C	D	F	G	E	
1/8	1/8	-BRD-FT2-FTD2	1.95(49.5)	0.50(12.7)	0.44(11.1)	0.50(12.7)	0.50(12.7)	0.08(2.0)	
1/4	1/4	-BRD-FT4-FTD4	2.20(55.9)	0.60(15.2)	0.56(14.3)	0.63(15.9)	0.63(15.9)	0.17(4.3)	
3/8	3/8	-BRD-FT6-FTD6	2.41(61.2)	0.66(16.8)	0.69(17.5)	0.75(19.1)	0.75(19.1)	0.27(6.9)	
1/2	1/2	-BRD-FT8-FTD8	2.87(72.9)	0.90(22.9)	0.87(22.2)	0.94(23.8)	0.94(23.8)	0.37(9.4)	
5/8	5/8	-BRD-FT10-FTD10	2.96(75.2)	0.96(24.4)	1.00(25.4)	1.06(27.0)	1.06(27.0)	0.47(11.9)	
3/4	3/4	-BRD-FT12-FTD12	3.21(81.5)	0.96(24.4)	1.13(28.6)	1.19(30.2)	1.19(30.2)	0.58(14.7)	
1	1	-BRD-FT16-FTD16	3.95(100.3)	1.23(31.2)	1.50(38.1)	1.63(41.3)	1.63(41.3)	0.80(20.3)	

Reducer Elbows

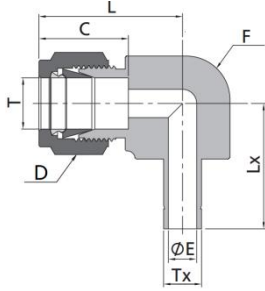

Metricl Tube								
T-Tube O.D.(mm)	Tx-Tube O.D.(mm)	Basic Ordering Number	Dimension, mm (in.)					
			L	C	D	F	G	E
6	6	-RDE-MT6-MTD6	27.0(1.06)	27.0(1.06)	27.0(1.06)	27.0(1.06)	27.0(1.06)	27.0(1.06)
12	12	-RDE-MT12-MTD12	38.1(1.50)	38.1(1.50)	38.1(1.50)	38.1(1.50)	38.1(1.50)	38.1(1.50)

Port Connectors

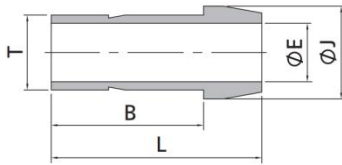

1" /25 mm and below

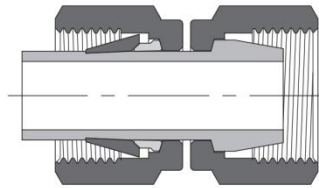

1 1/4" /28 mm and above

Fractional Tube					
T-Tube O.D.(in.)	Basic Ordering Number	Dimension, in. (mm)			
		L	F	B	E
1/16	-PC-FTD1	0.54(13.7)	0.42(10.7)	0.03(0.8)	0.13(3.3)
1/8	-PC-FTD2	0.88(22.4)	0.62(15.7)	0.08(2.0)	0.24(6.1)
1/4	-PC-FTD4	0.97(24.6)	0.74(18.8)	0.17(4.3)	0.37(9.4)
5/16	-PC-FTD5	1.02(25.9)	0.79(20.1)	0.22(5.6)	0.43(10.9)
3/8	-PC-FTD6	1.03(26.2)	0.80(20.3)	0.27(6.9)	0.50(12.7)
1/2	-PC-FTD8	1.41(35.8)	1.02(25.9)	0.37(9.4)	0.62(15.7)
5/8	-PC-FTD10	1.64(41.7)	1.11(28.1)	0.47(11.9)	0.81(20.5)
3/4	-PC-FTD12	1.65(41.9)	1.09(27.7)	0.58(14.7)	0.87(22.1)
1	-PC-FTD16	1.89(48.0)	1.36(34.5)	0.80(20.3)	1.12(28.4)
1 1/4	-PC-FTD20	2.72(69.1)	1.99(50.6)	1.02(25.9)	1.47(37.4)
1 1/2	-PC-FTD24	3.31(84.1)	2.34(59.4)	1.25(31.8)	1.80(45.8)

Metricl Tube					
T-Tube O.D.(mm)	Basic Ordering Number	Dimension, mm (in.)			
		L	F	B	E
3	-PC-MTD3	22.2(0.87)	15.7(0.62)	1.9(0.07)	6.0(0.24)
6	-PC-MTD6	24.6(0.97)	18.7(0.74)	4.1(0.16)	9.0(0.35)
8	-PC-MTD8	25.9(1.02)	20.0(0.79)	5.6(0.22)	11.0(0.43)
10	-PC-MTD10	26.1(1.03)	20.2(0.80)	7.1(0.28)	13.1(0.52)
12	-PC-MTD12	35.8(1.41)	26.0(1.02)	8.8(0.35)	15.0(0.59)
15	-PC-MTD15	37.8(1.49)	27.6(1.09)	11.2(0.44)	19.6(0.77)
16	-PC-MTD16	37.8(1.49)	27.6(1.09)	12.0(0.47)	20.6(0.81)
18	-PC-MTD18	37.8(1.49)	27.7(1.09)	13.9(0.55)	21.0(0.83)
20	-PC-MTD20	39.4(1.55)	29.2(1.15)	15.5(0.61)	24.6(0.97)
25	-PC-MTD25	49.3(1.94)	34.5(1.36)	19.9(0.78)	31.2(1.23)
28	-PC-MTD28	63.5(2.5)	48.3(1.90)	22.5(0.89)	34.4(1.35)
30	-PC-MTD30	67.6(2.66)	52.2(2.06)	24.3(0.96)	37.4(1.47)
32	-PC-MTD32	69.7(2.74)	52.4(2.06)	26.5(1.04)	39.4(1.55)
38	-PC-MTD38	81.9(3.22)	61.4(2.42)	31.6(1.24)	45.8(1.80)

Reducing Port Connectors

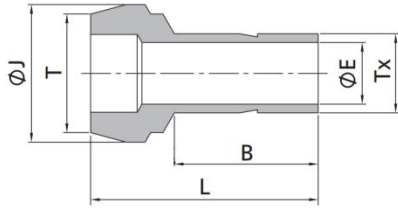

Fractional Tube						
T-Tube O.D.(in.)	Tx-Tube O.D.(in.)	Basic Ordering Number	Dimension, in. (mm)			
			L	B	E	J
1/8	1/16	-RPC-FT2-FTD1	0.68(17.3)	0.34(8.6)	0.03(0.8)	0.24(6.1)
1/4	1/16	-RPC-FT4-FTD1	0.71(18.0)	0.34(8.6)	0.03(0.8)	0.37(9.4)
1/4	1/8	-RPC-FT4-FTD2	0.89(22.6)	0.53(13.5)	0.08(2.0)	0.37(9.4)
3/8	1/8	-RPC-FT6-FTD2	0.91(23.1)	0.53(13.5)	0.08(2.0)	0.50(12.7)
3/8	1/4	-RPC-FT6-FTD4	0.98(24.9)	0.62(15.7)	0.17(4.3)	0.50(12.7)
1/2	1/4	-RPC-FT8-FTD4	1.15(29.2)	0.62(15.7)	0.17(4.3)	0.62(15.7)
1/2	3/8	-RPC-FT8-FTD6	1.20(30.5)	0.69(17.5)	0.27(6.9)	0.62(15.7)
3/4	1/2	-RPC-FT12-FTD8	1.49(37.8)	0.91(23.1)	0.37(9.4)	0.87(22.1)
1	1/2	-RPC-FT16-FTD8	1.69(42.9)	0.96(24.4)	0.37(9.4)	1.12(28.5)
1	3/4	-RPC-FT16-FTD12	1.72(43.7)	1.02(25.9)	0.58(14.7)	1.12(28.5)
Metric Tube						
T-Tube O.D.(mm)	T-Tube O.D.(mm)	Basic Ordering Number	Dimension, mm (in.)			
			L	B	E	J
6	3	-RPC-MT6-MTD3	22.6(0.89)	13.5(0.53)	1.9(0.07)	9.0(0.35)
8	6	-RPC-MT8-MTD6	24.7(0.97)	15.7(0.62)	4.1(0.16)	11.0(0.43)
10	6	-RPC-MT10-MTD6	25.0(0.98)	15.7(0.62)	4.1(0.16)	13.1(0.52)
10	8	-RPC-MT10-MTD8	26.3(1.04)	17.0(0.67)	5.6(0.22)	13.1(0.52)
12	6	-RPC-MT12-MTD6	29.6(1.17)	15.7(0.62)	4.1(0.16)	15.0(0.59)
12	8	-RPC-MT12-MTD8	29.8(1.17)	16.8(0.66)	5.6(0.22)	15.0(0.59)
12	10	-RPC-MT12-MTD10	30.4(1.20)	17.5(0.69)	7.1(0.28)	15.0(0.59)
16	12	-RPC-MT16-MTD12	36.2(1.43)	23.1(0.91)	8.8(0.35)	19.0(0.75)
28	25	-RPC-MT28-MTD25	56.5(2.22)	33.0(1.30)	19.8(0.78)	34.3(1.35)
32	25	-RPC-MT32-MTD25	60.3(2.37)	33.0(1.30)	19.8(0.78)	39.5(1.56)
38	25	-RPC-MT38-MTD25	65.8(2.59)	33.0(1.30)	19.8(0.78)	47.1(1.85)

Male Adaptors

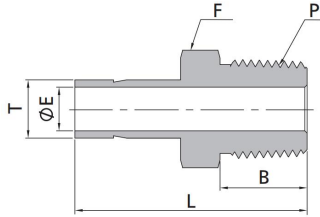

1" and below

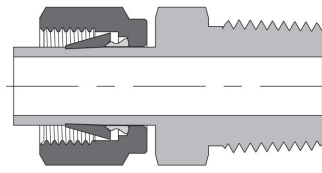

1 1/4" and above

Fractional Tube to NPT Thread

T-Tube O.D.(in.)	P-NPT Size	Basic Ordering Number	Dimension, in. (mm)			
			L	B	E	F
1/16	1/8	-MAD-FTD1-MN2	1.00(25.4)	0.38(9.7)	0.03(0.8)	0.44(11.1)
1/8	1/8	-MAD-FTD2-MN2	1.16(29.5)	0.38(9.7)	0.08(2.0)	0.44(11.1)
1/8	1/4	-MAD-FTD2-MN4	1.37(34.8)	0.56(14.2)	0.08(2.0)	0.56(14.3)
3/16	1/8	-MAD-FTD3-MN2	1.19(30.2)	0.38(9.7)	0.12(3.0)	0.44(11.1)
3/16	1/4	-MAD-FTD3-MN4	1.40(35.6)	0.56(14.2)	0.12(3.0)	0.56(14.3)
1/4	1/8	-MAD-FTD4-MN2	1.25(31.8)	0.38(9.7)	0.17(4.3)	0.44(11.1)
1/4	1/4	-MAD-FTD4-MN4	1.46(37.1)	0.56(14.2)	0.17(4.3)	0.56(14.3)
1/4	3/8	-MAD-FTD4-MN6	1.49(37.8)	0.56(14.2)	0.17(4.3)	0.69(17.5)
1/4	1/2	-MAD-FTD4-MN8	1.71(43.4)	0.75(19.1)	0.17(4.3)	0.87(22.2)
5/16	1/8	-MAD-FTD5-MN2	1.29(32.8)	0.38(9.7)	0.19(4.8)	0.44(11.1)
5/16	1/4	-MAD-FTD5-MN4	1.50(38.1)	0.56(14.2)	0.22(5.6)	0.56(14.3)
5/16	3/8	-MAD-FTD5-MN6	1.53(38.9)	0.56(14.2)	0.22(5.6)	0.69(17.5)
5/16	1/2	-MAD-FTD5-MN8	1.74(44.2)	0.75(19.1)	0.22(5.6)	0.87(22.2)
3/8	1/8	-MAD-FTD6-MN2	1.32(33.5)	0.38(9.7)	0.19(4.8)	0.44(11.1)
3/8	1/4	-MAD-FTD6-MN4	1.53(38.9)	0.56(14.2)	0.27(6.9)	0.56(14.3)
3/8	3/8	-MAD-FTD6-MN6	1.56(39.6)	0.56(14.2)	0.27(6.9)	0.69(17.5)
3/8	1/2	-MAD-FTD6-MN8	1.78(45.2)	0.75(19.1)	0.27(6.9)	0.87(22.2)
1/2	1/4	-MAD-FTD8-MN4	1.75(44.5)	0.56(14.2)	0.28(7.1)	0.56(14.3)
1/2	3/8	-MAD-FTD8-MN6	1.78(45.2)	0.56(14.2)	0.37(9.4)	0.69(17.5)
1/2	1/2	-MAD-FTD8-MN8	2.00(50.8)	0.75(19.1)	0.37(9.4)	0.87(22.2)
5/8	1/2	-MAD-FTD10-MN8	2.06(52.3)	0.75(19.1)	0.47(11.9)	0.87(22.2)
3/4	1/2	-MAD-FTD12-MN8	2.06(52.3)	0.75(19.1)	0.47(11.9)	0.87(22.2)
3/4	3/4	-MAD-FTD12-MN12	2.06(52.3)	0.75(19.1)	0.58(14.7)	1.06(27.0)
3/4	1	-MAD-FTD12-MN16	2.41(61.2)	0.94(23.9)	0.81(20.7)	1.37(34.9)
1	3/4	-MAD-FTD16-MN12	2.31(58.7)	0.75(19.1)	0.62(15.7)	1.06(27.0)
1	1	-MAD-FTD16-MN16	2.60(66.0)	0.94(23.9)	0.80(20.3)	1.37(34.9)
1 1/4	1 1/4	-MAD-FTD20-MN20	3.16(80.3)	0.94(23.9)	1.02(25.9)	1.75(44.5)
1 1/2	1 1/2	-MAD-FTD24-MN24	3.72(94.5)	1.03(26.2)	1.25(31.8)	2.13(54.0)

Fractional Tube to RT Thread

T-Tube O.D.(mm)	P-RT Size	Basic Ordering Number	Dimension, in. (mm)			
			L	B	E	F
1/8	1/8	-MAD-FTD2-RT2	1.00(25.4)	0.38(9.7)	0.03(0.8)	0.44(11.1)
1/8	1/4	-MAD-FTD2-RT4	1.16(29.5)	0.38(9.7)	0.08(2.0)	0.44(11.1)
1/4	1/8	-MAD-FTD4-RT2	1.37(34.8)	0.56(14.2)	0.08(2.0)	0.56(14.3)
1/4	1/4	-MAD-FTD4-RT4	1.19(30.2)	0.38(9.7)	0.12(3.0)	0.44(11.1)
1/4	3/8	-MAD-FTD4-RT6	1.40(35.6)	0.56(14.2)	0.12(3.0)	0.56(14.3)
1/4	1/2	-MAD-FTD4-RT8	1.25(31.8)	0.38(9.7)	0.17(4.3)	0.44(11.1)
5/16	1/8	-MAD-FTD5-RT2	1.46(37.1)	0.56(14.2)	0.17(4.3)	0.56(14.3)
5/16	1/4	-MAD-FTD5-RT4	1.49(37.8)	0.56(14.2)	0.17(4.3)	0.69(17.5)
3/8	1/4	-MAD-FTD6-RT4	1.71(43.4)	0.75(19.1)	0.17(4.3)	0.87(22.2)
3/8	3/8	-MAD-FTD6-RT6	1.29(32.8)	0.38(9.7)	0.19(4.8)	0.44(11.1)
3/8	1/2	-MAD-FTD6-RT8	1.50(38.1)	0.56(14.2)	0.22(5.6)	0.56(14.3)
1/2	1/4	-MAD-FTD8-RT4	1.53(38.9)	0.56(14.2)	0.22(5.6)	0.69(17.5)
1/2	3/8	-MAD-FTD8-RT6	1.74(44.2)	0.75(19.1)	0.22(5.6)	0.87(22.2)
1/2	1/2	-MAD-FTD8-RT8	1.32(33.5)	0.38(9.7)	0.19(4.8)	0.44(11.1)
5/8	3/8	-MAD-FTD10-RT6	1.53(38.9)	0.56(14.2)	0.27(6.9)	0.56(14.3)
5/8	1/2	-MAD-FTD10-RT8	1.56(39.6)	0.56(14.2)	0.27(6.9)	0.69(17.5)
3/4	3/4	-MAD-FTD12-RT12	1.78(45.2)	0.75(19.1)	0.27(6.9)	0.87(22.2)
1	1	-MAD-FTD16-RT16	1.75(44.5)	0.56(14.2)	0.28(7.1)	0.56(14.3)

Male Adaptors

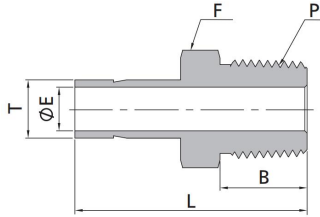

1" and below

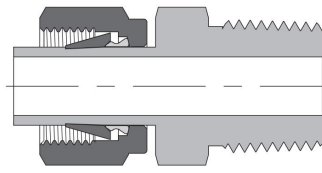

1 1/4" and above

Metricl Tube to NPT Thread

T-Tube O.D.(mm)	P-NPT Size	Basic Ordering Number	Dimension, mm (in.)			
			L	B	E	F
3	1/8	-MAD-MTD3-MN2	29.4(1.16)	9.7(0.38)	1.8(0.07)	12.0(0.47)
4	1/8	-MAD-MTD4-MN2	29.4(1.16)	9.7(0.38)	2.0(0.08)	12.0(0.47)
6	1/8	-MAD-MTD6-MN2	32.8(1.29)	9.7(0.38)	4.1(0.16)	12.0(0.47)
6	1/4	-MAD-MTD6-MN4	38.1(1.50)	14.2(0.56)	4.1(0.16)	14.0(0.55)
6	3/8	-MAD-MTD6-MN6	39.2(1.54)	14.2(0.56)	4.1(0.16)	18.0(0.71)
6	1/2	-MAD-MTD6-MN8	42.1(1.66)	19.1(0.75)	4.1(0.16)	22.0(0.87)
8	1/4	-MAD-MTD8-MN4	39.1(1.54)	14.2(0.56)	5.6(0.22)	14.0(0.55)
8	3/8	-MAD-MTD8-MN6	39.9(1.57)	14.2(0.56)	5.6(0.22)	19.0(0.75)
10	1/4	-MAD-MTD10-MN4	39.9(1.57)	14.2(0.56)	7.1(0.28)	14.0(0.55)
10	3/8	-MAD-MTD10-MN6	40.6(1.60)	14.2(0.56)	7.1(0.28)	18.0(0.71)
10	1/2	-MAD-MTD10-MN8	46.2(1.82)	19.1(0.75)	7.1(0.28)	22.0(0.87)
12	1/4	-MAD-MTD12-MN4	46.5(1.83)	14.2(0.56)	7.1(0.28)	14.0(0.55)
12	3/8	-MAD-MTD12-MN6	46.2(1.82)	14.2(0.56)	8.8(0.35)	18.0(0.71)
12	1/2	-MAD-MTD12-MN8	52.1(2.05)	19.1(0.75)	8.8(0.35)	22.0(0.87)
16	1/2	-MAD-MTD16-MN8	50.8(2.00)	19.1(0.75)	12.7(0.50)	22.0(0.87)
16	3/4	-MAD-MTD16-MN12	51.6(2.03)	19.1(0.75)	12.7(0.50)	27.0(1.06)
18	1/2	-MAD-MTD18-MN8	50.8(2.00)	19.1(0.75)	12.7(0.50)	27.0(1.06)
18	3/4	-MAD-MTD18-MN12	51.6(2.03)	19.1(0.75)	14.0(0.55)	27.0(1.06)
20	1/2	-MAD-MTD20-MN8	51.8(2.04)	19.1(0.75)	11.9(0.47)	22.0(0.87)
20	3/4	-MAD-MTD20-MN12	52.4(2.06)	19.1(0.75)	15.1(0.59)	27.0(1.06)
25	1	-MAD-MTD25-MN16	65.9(2.59)	23.9(0.94)	19.8(0.78)	35.0(1.38)
28	1	-MAD-MTD28-MN16	74.4(2.93)	23.9(0.94)	22.2(0.87)	35.0(1.38)
28	1 1/4	-MAD-MTD28-MN20	76.2(3.00)	23.9(0.94)	22.5(0.89)	46.0(1.81)
30	1	-MAD-MTD30-MN16	79.2(3.12)	23.9(0.94)	22.2(0.87)	41.0(1.61)
30	1 1/4	-MAD-MTD30-MN20	80.0(3.15)	23.9(0.94)	24.3(0.96)	46.0(1.81)
32	1 1/4	-MAD-MTD32-MN20	81.0(3.19)	23.9(0.94)	26.5(1.04)	46.0(1.81)
38	1 1/2	-MAD-MTD38-MN24	92.2(3.63)	26.2(1.03)	31.6(1.24)	55.0(2.17)
1 1/2	1 1/2	-MAD-FTD24-MN24	3.72(94.5)	1.03(26.2)	1.25(31.8)	2.13(54.0)

Metricl Tube to RT Thread

T-Tube O.D.(mm)	P-RT Size	Basic Ordering Number	Dimension, mm (in.)			
			L	B	E	F
3	1/8	-MAD-MTD3-RT2	29.4(1.16)	9.7(0.38)	1.8(0.07)	12.0(0.47)
4	1/8	-MAD-MTD4-RT2	29.4(1.16)	9.7(0.38)	2.0(0.08)	12.0(0.47)
6	1/8	-MAD-MTD6-RT2	32.8(1.29)	9.7(0.38)	4.1(0.16)	12.0(0.47)
6	1/4	-MAD-MTD6-RT4	38.1(1.50)	14.2(0.56)	4.1(0.16)	14.0(0.55)
8	1/4	-MAD-MTD8-RT4	39.1(1.54)	14.2(0.56)	5.6(0.22)	14.0(0.55)
8	3/8	-MAD-MTD8-RT6	39.9(1.57)	14.2(0.56)	5.6(0.22)	18.0(0.71)
10	1/4	-MAD-MTD10-RT4	39.9(1.57)	14.2(0.56)	7.1(0.28)	14.0(0.55)
10	3/8	-MAD-MTD10-RT6	40.6(1.60)	14.2(0.56)	7.1(0.28)	18.0(0.71)
10	1/2	-MAD-MTD10-RT8	44.5(1.75)	19.1(0.75)	7.5(0.30)	22.0(0.87)
12	1/4	-MAD-MTD12-RT4	46.5(1.83)	14.2(0.56)	7.1(0.28)	16.0(0.63)
12	3/8	-MAD-MTD12-RT6	46.2(1.82)	14.2(0.56)	8.8(0.35)	18.0(0.71)
12	1/2	-MAD-MTD12-RT8	51.8(2.04)	19.1(0.75)	8.8(0.35)	22.0(0.87)
16	1/2	-MAD-MTD16-RT8	50.8(2.00)	19.1(0.75)	12.7(0.50)	22.0(0.87)
18	3/4	-MAD-MTD18-RT12	51.6(2.03)	19.1(0.75)	14.0(0.55)	27.0(1.06)
20	3/4	-MAD-MTD20-RT12	52.4(2.06)	19.1(0.75)	15.1(0.59)	27.0(1.06)
25	1	-MAD-MTD25-RT16	65.9(2.59)	23.9(0.94)	19.8(0.78)	35.0(1.38)
28	1	-MAD-MTD28-RT16	74.7(2.94)	23.9(0.94)	22.2(0.87)	35.0(1.38)
28	1 1/4	-MAD-MTD28-RT20	76.2(3.00)	23.9(0.94)	22.5(0.89)	46.0(1.81)
30	1 1/4	-MAD-MTD30-RT20	80.0(3.15)	23.9(0.94)	24.3(0.96)	46.0(1.81)
32	1 1/4	-MAD-MTD32-RT20	81.0(3.19)	23.9(0.94)	26.5(1.04)	46.0(1.81)
38	1 1/2	-MAD-MTD38-RT24	92.2(3.63)	26.2(1.03)	31.6(1.24)	55.0(2.17)

Male Adaptors

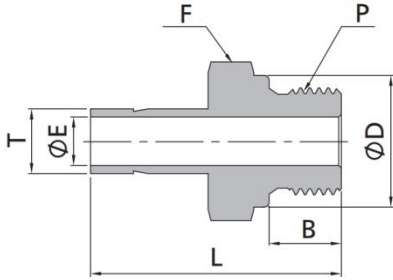

Fractional Tube to ISO Parallel Thread							
T-Tube O.D.(in.)	P-RP Size	Basic Ordering Number	Dimension, in. (mm)				
			L	B	E	F	D
1/8	1/8	-MAD-FTD2-RS2	1.22(31.0)	0.28(7.1)	0.08(2.0)	0.56(14.3)	0.54(13.7)
1/8	1/4	-MAD-FTD2-RS4	1.41(35.8)	0.44(11.2)	0.08(2.0)	0.75(19.1)	0.70(17.8)
1/4	1/8	-MAD-FTD4-RS2	1.31(33.3)	0.28(7.1)	0.16(4.1)	0.56(14.3)	0.54(13.7)
1/4	1/4	-MAD-FTD4-RS4	1.50(38.1)	0.44(11.2)	0.17(4.3)	0.75(19.1)	0.70(17.8)
3/8	1/8	-MAD-FTD6-RS2	1.34(34.0)	0.28(7.1)	0.05(1.3)	0.56(14.3)	0.54(13.7)
3/8	1/4	-MAD-FTD6-RS4	1.57(39.9)	0.44(11.2)	0.23(5.8)	0.75(19.1)	0.70(17.8)
3/8	3/8	-MAD-FTD6-RS6	1.60(40.6)	0.44(11.2)	0.27(6.9)	0.87(22.2)	0.85(21.6)
3/8	1/2	-MAD-FTD6-RS8	1.69(42.9)	0.56(14.2)	0.28(7.1)	1.06(27.0)	1.02(25.9)
1/2	1/4	-MAD-FTD8-RS4	1.79(45.5)	0.44(11.2)	0.23(5.8)	0.75(19.1)	0.70(17.8)
1/2	3/8	-MAD-FTD8-RS6	1.82(46.2)	0.44(11.2)	0.31(7.9)	0.87(22.2)	0.85(21.6)
1/2	1/2	-MAD-FTD8-RS8	1.94(49.2)	0.56(14.2)	0.37(9.4)	1.06(27.0)	1.02(25.9)
5/8	1/2	-MAD-FTD10-RS8	1.97(50.0)	0.56(14.2)	0.47(11.9)	1.06(27.0)	1.02(25.9)
3/4	3/4	-MAD-FTD12-RS12	2.16(54.9)	0.63(16.0)	0.58(14.7)	1.31(33.3)	1.26(32.0)
1	1	-MAD-FTD16-RS16	2.54(64.5)	0.72(18.3)	0.80(20.3)	1.63(41.3)	1.53(38.9)

Metric Tube to ISO Parallel Thread							
T-Tube O.D.(mm)	P-RS Size	Basic Ordering Number	Dimension, mm (in.)				
			L	B	E	F	D
3	1/8	-MAD-MTD3-RS2	31.0(1.22)	7.1(0.28)	1.8(0.07)	14.0(0.55)	13.7(0.54)
4	1/8	-MAD-MTD4-RS2	31.8(1.25)	7.1(0.28)	2.0(0.08)	14.0(0.55)	13.7(0.54)
6	1/8	-MAD-MTD6-RS2	34.3(1.35)	7.1(0.28)	4.0(0.16)	14.0(0.55)	13.7(0.54)
6	1/4	-MAD-MTD6-RS4	39.1(1.54)	11.2(0.44)	4.1(0.16)	19.0(0.75)	17.8(0.70)
8	1/4	-MAD-MTD8-RS4	40.1(1.58)	11.2(0.44)	5.6(0.22)	19.0(0.75)	17.8(0.70)
10	1/4	-MAD-MTD10-RS4	40.9(1.61)	11.2(0.44)	5.9(0.23)	19.0(0.75)	17.8(0.70)
10	3/8	-MAD-MTD10-RS6	41.7(1.64)	11.2(0.44)	7.1(0.28)	22.0(0.87)	21.6(0.85)
10	1/2	-MAD-MTD10-RS8	44.7(1.76)	14.2(0.56)	7.1(0.28)	27.0(1.06)	25.9(1.02)
12	1/4	-MAD-MTD12-RS4	46.7(1.84)	11.2(0.44)	5.9(0.23)	19.0(0.75)	17.8(0.70)
12	3/8	-MAD-MTD12-RS6	47.2(1.86)	11.2(0.44)	7.9(0.31)	22.0(0.87)	21.6(0.85)
12	1/2	-MAD-MTD12-RS8	50.5(1.99)	14.2(0.56)	8.8(0.35)	27.0(1.06)	25.9(1.02)
16	1/2	-MAD-MTD16-RS8	50.8(2.00)	14.2(0.56)	11.9(0.47)	27.0(1.06)	25.9(1.02)
18	3/4	-MAD-MTD18-RS12	55.9(2.20)	16.0(0.63)	13.9(0.55)	35.0(1.38)	32.0(1.26)
20	3/4	-MAD-MTD20-RS12	57.0(2.24)	16.0(0.63)	15.1(0.59)	33.0(1.30)	32.0(1.26)
25	1	-MAD-MTD25-RS16	65.1(2.56)	18.3(0.72)	19.8(0.78)	41.0(1.61)	38.9(1.53)

Male Adaptors

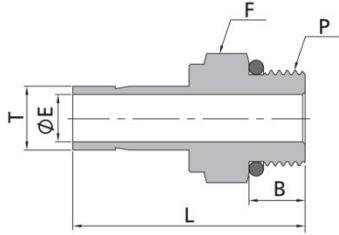

Fractional Tube to SAE/MS Thread						
T-Tube O.D.(in.)	P-SAE/MS Size	Basic Ordering Number	Dimension, in. (mm)			
			L	B	E	F
1/8	5/16-24	-MAD-FTD2-ST5	1.20(30.5)	0.30(7.6)	0.08(2.0)	0.44(11.1)
1/4	7/16-20	-MAD-FTD4-ST7	1.39(35.3)	0.36(9.1)	0.17(4.3)	0.56(14.3)
3/8	7/16-20	-MAD-FTD6-ST7	1.46(37.1)	0.36(9.1)	0.20(5.1)	0.56(14.3)
3/8	9/16-18	-MAD-FTD6-ST9	1.52(38.6)	0.39(9.9)	0.27(6.9)	0.69(17.5)
3/8	3/4-16	-MAD-FTD6-ST12	1.60(40.6)	0.44(11.2)	0.27(6.9)	0.87(22.2)
1/2	9/16-18	-MAD-FTD8-ST9	1.74(44.2)	0.39(9.9)	0.28(7.1)	0.69(17.5)
1/2	3/4-16	-MAD-FTD8-ST12	1.82(46.2)	0.44(11.2)	0.37(9.4)	0.87(22.2)
5/8	7/8-14	-MAD-FTD10-ST14	1.94(49.3)	0.50(12.7)	0.47(11.9)	1.00(25.4)
3/4	1 1/16-12	-MAD-FTD12-ST17	2.10(53.3)	0.59(15.0)	0.58(14.7)	1.25(31.8)
1	1 5/16-12	-MAD-FTD16-ST21	2.41(61.2)	0.59(15.0)	0.80(20.3)	1.50(38.1)

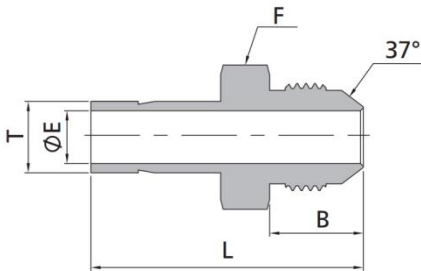

Fractional Tube to Flared						
T-Tube O.D.(in.)	Tube Flared Size	Basic Ordering Number	Dimension, in. (mm)			
			L	B	E	F
1/4	1/4	-MAD-FTD4-AN4	1.46(37.1)	0.55(14.0)	0.17(4.3)	0.50(12.7)
3/8	1/4	-MAD-FTD6-AN4	1.53(38.9)	0.55(14.0)	0.17(4.3)	0.50(12.7)
3/8	3/8	-MAD-FTD6-AN6	1.56(39.6)	0.56(14.2)	0.27(6.9)	0.63(15.9)
1/2	1/2	-MAD-FTD8-AN8	1.91(48.5)	0.66(16.8)	0.37(9.4)	0.81(20.6)
3/4	3/4	-MAD-FTD12-AN12	2.21(56.1)	0.86(21.8)	0.58(14.7)	1.13(28.6)
1	1	-MAD-FTD16-AN16	2.58(65.5)	0.91(23.1)	0.80(20.3)	1.37(34.9)

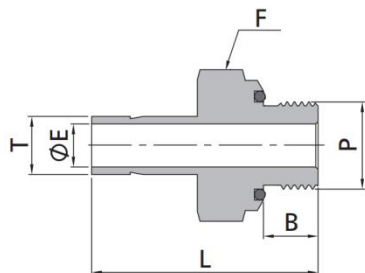

Fractional Tube to SAE/MS Thread						
T-Tube O.D.(in.)	P-SAE/MS Thread	Basic Ordering Number	Dimension, in. (mm)			
			L	B	E	F
1/8	5/16-24	-MAD-FTD2-OS5	1.28(32.5)	0.34(8.6)	0.08(2.0)	0.56(14.3)
3/16	3/8-24	-MAD-FTD3-OS6	1.38(35.1)	0.38(9.7)	0.12(3.0)	0.63(15.9)
1/4	7/16-20	-MAD-FTD4-OS7	1.54(39.1)	0.41(10.4)	0.17(4.3)	0.75(19.1)
5/16	1/2-20	-MAD-FTD5-OS8	1.64(41.7)	0.44(11.2)	0.22(5.6)	0.87(22.2)
3/8	9/16-18	-MAD-FTD6-OS9	1.70(43.2)	0.47(11.9)	0.27(6.9)	0.94(23.8)
1/2	3/4-16	-MAD-FTD8-OS12	1.95(49.5)	0.47(11.9)	0.37(9.4)	1.13(28.6)

Female Adaptors

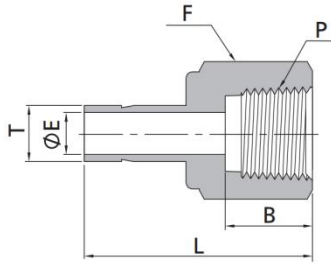

1" and below

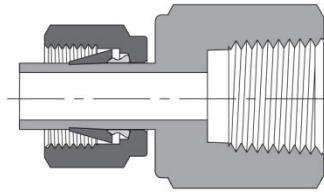

1 1/4" and above

Fractional Tube to NPT Thread

T-Tube O.D.(in.)	P-NPT Size	Basic Ordering Number	Dimension, in. (mm)			
			L	B	E	F
1/16	1/8	-FAD-FTD1-FN2	1.07(27.2)	0.41(10.4)	0.03(0.8)	0.56(14.3)
1/8	1/8	-FAD-FTD2-FN2	1.24(31.5)	0.41(10.4)	0.08(2.0)	0.56(14.3)
1/8	1/4	-FAD-FTD2-FN4	1.39(35.3)	0.59(15.0)	0.08(2.0)	0.75(19.1)
3/16	1/8	-FAD-FTD3-FN2	1.25(31.8)	0.41(10.4)	0.11(2.9)	0.56(14.3)
3/16	1/4	-FAD-FTD3-FN4	1.41(35.8)	0.59(15.0)	0.12(3.0)	0.75(19.1)
1/4	1/8	-FAD-FTD4-FN2	1.30(33.0)	0.41(10.4)	0.17(4.3)	0.56(14.3)
1/4	1/4	-FAD-FTD4-FN4	1.46(37.1)	0.59(15.0)	0.17(4.3)	0.75(19.1)
1/4	3/8	-FAD-FTD4-FN6	1.55(39.4)	0.59(15.0)	0.17(4.3)	0.87(22.2)
1/4	1/2	-FAD-FTD4-FN8	1.79(45.5)	0.78(19.8)	0.17(4.3)	1.06(27.0)
5/16	1/8	-FAD-FTD5-FN2	1.34(34.0)	0.41(10.4)	0.22(5.6)	0.56(14.3)
5/16	1/4	-FAD-FTD5-FN4	1.48(37.6)	0.59(15.0)	0.22(5.6)	0.75(19.1)
5/16	3/8	-FAD-FTD5-FN6	1.59(40.4)	0.59(15.0)	0.22(5.6)	0.87(22.2)
3/8	1/8	-FAD-FTD6-FN2	1.35(34.3)	0.41(10.4)	0.27(6.9)	0.56(14.3)
3/8	1/4	-FAD-FTD6-FN4	1.50(38.1)	0.59(15.0)	0.27(6.9)	0.75(19.1)
3/8	3/8	-FAD-FTD6-FN6	1.59(40.4)	0.59(15.0)	0.27(6.9)	0.87(22.2)
3/8	1/2	-FAD-FTD6-FN8	1.84(46.7)	0.78(19.8)	0.27(6.9)	1.06(27.0)
1/2	1/4	-FAD-FTD8-FN4	1.71(43.4)	0.59(15.0)	0.37(9.4)	0.75(19.1)
1/2	3/8	-FAD-FTD8-FN6	1.79(45.5)	0.59(15.0)	0.37(9.4)	0.87(22.2)
1/2	1/2	-FAD-FTD8-FN8	2.04(51.8)	0.78(19.8)	0.37(9.4)	1.06(27.0)
5/8	3/8	-FAD-FTD10-FN6	1.86(47.2)	0.59(15.0)	0.47(11.9)	0.87(22.2)
5/8	1/2	-FAD-FTD10-FN8	2.09(53.1)	0.78(19.8)	0.47(11.9)	1.06(27.0)
3/4	1/2	-FAD-FTD12-FN8	2.08(52.8)	0.78(19.8)	0.58(14.7)	1.06(27.0)
3/4	3/4	-FAD-FTD12-FN12	2.16(54.9)	0.81(20.6)	0.58(14.7)	1.31(33.3)
3/4	1	-FAD-FTD12-FN16	2.30(58.4)	1.00(25.4)	0.58(14.7)	1.63(41.3)
7/8	3/4	-FAD-FTD14-FN12	2.22(56.4)	0.81(20.6)	0.58(14.7)	1.31(33.3)
1	3/4	-FAD-FTD16-FN12	2.39(60.7)	0.81(20.6)	0.80(20.3)	1.31(33.3)
1	1	-FAD-FTD16-FN16	2.53(64.3)	1.00(25.4)	0.80(20.3)	1.63(41.3)
1 1/4	1 1/4	-FAD-FTD20-FN20	3.06(77.7)	1.00(25.4)	1.02(25.9)	2.13(54.0)
1 1/2	1 1/2	-FAD-FTD24-FN24	3.50(88.9)	1.09(27.7)	1.25(31.8)	2.37(60.3)

Fractional Tube to ISO Parallel Thread

T-Tube O.D.(in.)	P-RT Size	Basic Ordering Number	Dimension, in. (mm)			
			L	B	E	F
1/4	1/8	-FAD-FTD4-FR2	1.30(33.0)	0.41(10.4)	0.17(4.3)	0.56(14.3)
1/4	1/4	-FAD-FTD4-FR4	1.45(36.8)	0.59(15.0)	0.17(4.3)	0.75(19.1)
3/8	1/4	-FAD-FTD6-FR4	1.50(38.1)	0.59(15.0)	0.27(6.9)	0.75(19.1)
3/8	3/8	-FAD-FTD6-FR6	1.59(40.4)	0.59(15.0)	0.27(6.9)	0.87(22.2)
1/2	1/4	-FAD-FTD8-FR4	1.71(43.4)	0.59(15.0)	0.37(9.4)	0.75(19.1)
1/2	3/8	-FAD-FTD8-FR6	1.80(45.7)	0.59(15.0)	0.37(9.4)	0.87(22.2)
1/2	1/2	-FAD-FTD8-FR8	2.05(52.1)	0.78(19.8)	0.37(9.4)	1.06(27.0)

Female Adaptors

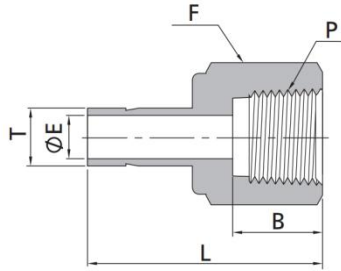

Metricl Tube to NPT Thread						
T-Tube O.D.(in.)	P-NPT Size	Basic Ordering Number	Dimension, mm (in.)			
			L	B	E	F
3	1/8	-FAD-MTD3-FN2	28.8(1.13)	10.4(0.41)	1.3(0.05)	14.0(0.55)
4	1/8	-FAD-MTD4-FN2	33.3(1.31)	10.4(0.41)	2.0(0.08)	14.0(0.55)
6	1/8	-FAD-MTD6-FN2	32.5(1.28)	10.4(0.41)	4.1(0.16)	14.0(0.55)
6	1/4	-FAD-MTD6-FN4	37.1(1.46)	15.0(0.59)	4.1(0.16)	19.0(0.75)
8	1/8	-FAD-MTD8-FN2	35.1(1.38)	10.4(0.41)	6.4(0.25)	14.0(0.55)
8	1/4	-FAD-MTD8-FN4	37.6(1.48)	15.0(0.59)	5.6(0.22)	19.0(0.75)
8	3/8	-FAD-MTD8-FN6	36.5(1.44)	15.0(0.59)	6.4(0.25)	22.0(0.87)
10	1/4	-FAD-MTD10-FN4	38.1(1.50)	15.0(0.59)	7.1(0.28)	19.0(0.75)
10	3/8	-FAD-MTD10-FN6	40.1(1.58)	15.0(0.59)	7.1(0.28)	22.0(0.87)
10	1/2	-FAD-MTD10-FN8	46.5(1.83)	19.8(0.78)	7.1(0.28)	27.0(1.06)
12	1/4	-FAD-MTD12-FN4	43.7(1.72)	15.0(0.59)	8.8(0.35)	19.0(0.75)
12	3/8	-FAD-MTD12-FN6	42.9(1.69)	15.0(0.59)	9.1(0.36)	22.0(0.87)
12	1/2	-FAD-MTD12-FN8	52.3(2.06)	19.8(0.78)	8.8(0.35)	27.0(1.06)
16	1/2	-FAD-MTD16-FN8	49.2(1.94)	19.8(0.78)	12.7(0.50)	27.0(1.06)
18	3/4	-FAD-MTD18-FN12	52.4(2.06)	20.6(0.81)	14.0(0.55)	32.0(1.26)
20	1/2	-FAD-MTD20-FN8	50.0(1.97)	19.8(0.78)	15.0(0.59)	27.0(1.06)
20	3/4	-FAD-MTD20-FN12	53.2(2.09)	20.6(0.81)	15.1(0.59)	32.0(1.26)
25	1	-FAD-MTD25-FN16	66.7(2.63)	25.4(1.00)	19.8(0.78)	41.0(1.61)
Metricl Tube to ISO Parallel Thread						
T-Tube O.D.(in.)	P-RT Size	Basic Ordering Number	Dimension, mm (in.)			
			L	B	E	F
3	1/8	-FAD-MTD3-FR2	27.8(1.09)	10.4(0.41)	1.8(0.07)	14.0(0.55)
4	1/8	-FAD-MTD4-FR2	28.6(1.13)	10.4(0.41)	2.0(0.08)	14.0(0.55)
6	1/8	-FAD-MTD6-FR2	33.0(1.30)	10.4(0.41)	4.1(0.16)	14.0(0.55)
8	1/4	-FAD-MTD8-FR4	37.6(1.48)	15.0(0.59)	5.6(0.22)	19.0(0.75)
10	1/4	-FAD-MTD10-FR4	38.1(1.50)	15.0(0.59)	7.1(0.28)	19.0(0.75)
10	3/8	-FAD-MTD10-FR6	36.5(1.44)	15.0(0.59)	7.5(0.30)	22.0(0.87)
10	1/2	-FAD-MTD10-FR8	41.3(1.63)	19.8(0.78)	7.5(0.30)	27.0(1.06)
12	1/4	-FAD-MTD12-FR4	40.5(1.59)	15.0(0.59)	9.1(0.36)	19.0(0.75)
12	3/8	-FAD-MTD12-FR6	43.7(1.72)	15.0(0.59)	9.1(0.36)	22.0(0.87)
12	1/2	-FAD-MTD12-FR8	46.8(1.84)	19.8(0.78)	9.1(0.36)	27.0(1.06)
16	1/2	-FAD-MTD16-FR8	48.4(1.91)	19.8(0.78)	12.7(0.50)	27.0(1.06)
18	3/4	-FAD-MTD18-FR12	52.4(2.06)	20.6(0.81)	14.0(0.55)	32.0(1.26)
20	3/4	-FAD-MTD20-FR12	53.2(2.09)	20.6(0.81)	15.1(0.59)	32.0(1.26)
25	1	-FAD-MTD25-FR16	66.7(2.63)	25.4(1.00)	19.8(0.78)	41.0(1.61)

Female Adaptors

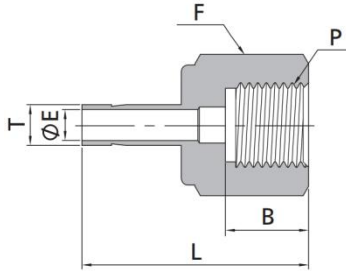

Metricl Tube to ISO Parallel Thread

T-Tube O.D.(in.)	P-BSP Size	Basic Ordering Number	Dimension, mm (in.)			
			L	B	E	F
3	1/8	-FAD-MTD3-FG2	28.6(1.13)	6.5(0.26)	1.6(0.06)	14.0(0.55)
3	1/4	-FAD-MTD3-FG4	33.5(1.32)	10.2(0.40)	1.9(0.07)	19.0(0.75)
4	1/8	-FAD-MTD4-FG2	29.4(1.16)	6.5(0.26)	2.0(0.08)	14.0(0.55)
6	1/8	-FAD-MTD6-FG2	31.0(1.22)	6.5(0.26)	4.1(0.16)	14.0(0.55)
6	1/4	-FAD-MTD6-FG4	35.3(1.39)	10.2(0.40)	4.1(0.16)	19.0(0.75)
6	3/8	-FAD-MTD6-FG6	38.4(1.51)	14.2(0.56)	4.1(0.16)	24.0(0.94)
6	1/2	-FAD-MTD6-FG8	42.9(1.69)	18.0(0.71)	4.1(0.16)	27.0(1.06)
8	1/4	-FAD-MTD8-FG4	33.0(1.30)	10.2(0.40)	5.5(0.22)	19.0(0.75)
8	3/8	-FAD-MTD8-FG6	38.9(1.53)	14.2(0.56)	5.6(0.22)	24.0(0.94)
8	1/2	-FAD-MTD8-FG8	43.7(1.72)	18.0(0.71)	5.6(0.22)	27.0(1.06)
10	1/4	-FAD-MTD10-FG4	34.5(1.36)	10.2(0.40)	5.5(0.22)	19.0(0.75)
10	3/8	-FAD-MTD10-FG6	36.1(1.42)	14.2(0.56)	6.5(0.26)	24.0(0.94)
10	1/2	-FAD-MTD10-FG8	41.1(1.62)	18.0(0.71)	7.1(0.28)	27.0(1.06)
12	1/4	-FAD-MTD12-FG4	41.1(1.62)	10.2(0.40)	5.5(0.22)	19.0(0.75)
12	3/8	-FAD-MTD12-FG6	44.7(1.76)	14.2(0.56)	6.5(0.26)	24.0(0.94)
12	1/2	-FAD-MTD12-FG8	48.8(1.92)	18.0(0.71)	7.0(0.28)	27.0(1.06)
16	1/2	-FAD-MTD16-FG8	49.0(1.93)	18.0(0.71)	7.0(0.28)	27.0(1.06)
18	1/2	-FAD-MTD18-FG8	49.3(1.94)	18.0(0.71)	7.0(0.28)	27.0(1.06)

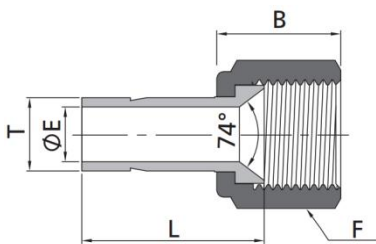

Fractional Tube to Fraed

T-Tube O.D.(in.)	Tube Flared Size	Basic Ordering Number	Dimension, in. (mm)			
			L	B	E	F
1/8	1/8	-FAD-FTD2-FAN2	0.88(22.4)	0.55(14.0)	0.09(2.4)	0.37(9.5)
1/8	1/4	-FAD-FTD2-FAN4	0.88(22.4)	0.62(15.8)	0.09(2.4)	0.56(14.3)
1/4	1/4	-FAD-FTD4-FAN4	0.96(24.4)	0.62(15.8)	0.18(4.6)	0.56(14.3)
3/8	3/8	-FAD-FTD6-FAN6	1.11(28.1)	0.73(18.5)	0.28(7.1)	0.69(17.5)
1/2	1/2	-FAD-FTD8-FAN8	1.42(36.1)	0.85(21.6)	0.39(9.9)	0.87(22.2)
3/4	3/4	-FAD-FTD12-FAN12	1.49(37.8)	1.03(26.2)	0.58(14.7)	1.25(31.8)

Weld Adaptors

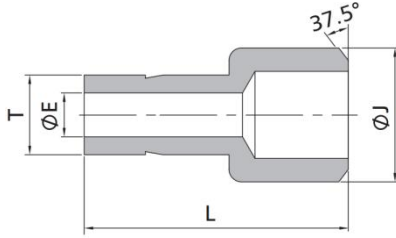

Fractional Tube to Pipe Weld

T-Tube O.D. (in.)	Pipe Weld Size	Basic Ordering Number	Dimension, in. (mm)		
			L	J	E
1/4	1/4	-WAD-FTD4-BW4	1.14(29.0)	0.54(13.7)	0.17(4.3)
3/8	1/2	-WAD-FTD6-BW8	1.46(37.1)	0.84(21.3)	0.27(6.9)
1/2	1/2	-WAD-FTD8-BW8	1.66(42.2)	0.84(21.3)	0.37(9.4)
1/2	3/4	-WAD-FTD8-BW12	1.68(42.7)	1.05(26.7)	0.37(9.4)
3/4	3/4	-WAD-FTD12-BW12	1.87(47.5)	1.05(26.7)	0.58(14.7)

Weld Connectors

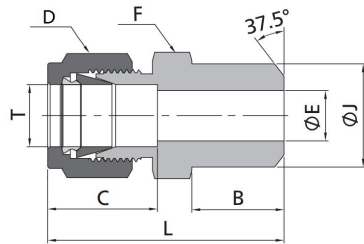

Fractional Tube to Pipe Butt Weld

T-Tube O.D.(in.)	Pipe Weld SIZE	Basic Ordering Number	Dimension,in(mm)						
			L	C	D	F	E	B	J
1/8	1/8	-WDC-FT2-BW2	1.20(30.5)	0.50(12.7)	0.44(11.1)	0.44(11.1)	0.09(2.3)	0.38(9.7)	0.41(10.3)
3/16	1/8	-WDC-FT3-BW2	1.23(31.2)	0.54(13.7)	0.50(12.7)	0.44(11.1)	0.12(3.0)	0.38(9.7)	0.41(10.3)
1/4	1/8	-WDC-FT4-BW2	1.29(32.8)	0.60(15.2)	0.56(14.3)	0.50(12.7)	0.19(4.8)	0.38(9.7)	0.41(10.3)
1/4	1/4	-WDC-FT4-BW4	1.49(37.8)	0.60(15.2)	0.56(14.3)	0.56(14.3)	0.19(4.8)	0.56(14.2)	0.54(13.7)
5/16	1/8	-WDC-FT5-BW2	1.34(34.0)	0.64(16.3)	0.63(15.9)	0.56(14.3)	0.21(5.3)	0.38(9.7)	0.41(10.3)
5/16	1/4	-WDC-FT5-BW4	1.52(38.6)	0.64(16.3)	0.63(15.9)	0.56(14.3)	0.25(6.4)	0.56(14.2)	0.54(13.7)
3/8	1/4	-WDC-FT6-BW4	1.57(39.9)	0.66(16.8)	0.69(17.5)	0.63(15.9)	0.28(7.1)	0.56(14.2)	0.54(13.7)
3/8	3/8	-WDC-FT6-BW6	1.57(39.9)	0.66(16.8)	0.69(17.5)	0.69(17.5)	0.28(7.1)	0.56(14.2)	0.67(17.1)
3/8	1/2	-WDC-FT6-BW8	1.82(46.2)	0.66(16.8)	0.69(17.5)	0.87(22.2)	0.28(7.1)	0.75(19.1)	0.84(21.3)
3/8	3/4	-WDC-FT6-BW12	1.88(47.8)	0.66(16.8)	0.69(17.5)	1.06(27.0)	0.28(7.1)	0.75(19.1)	1.05(26.7)
1/2	3/8	-WDC-FT8-BW6	1.71(43.4)	0.90(22.9)	0.87(22.2)	0.81(20.6)	0.41(10.4)	0.56(14.2)	0.67(17.1)
1/2	1/2	-WDC-FT8-BW8	1.93(49.0)	0.90(22.9)	0.87(22.2)	0.87(22.2)	0.41(10.4)	0.75(19.1)	0.84(21.3)
1/2	3/4	-WDC-FT8-BW12	1.99(50.5)	0.90(22.9)	0.87(22.2)	1.06(27.0)	0.41(10.4)	0.75(19.1)	1.05(26.7)
5/8	1/2	-WDC-FT10-BW8	1.93(49.0)	0.96(24.4)	1.00(25.4)	0.94(23.8)	0.50(12.7)	0.75(19.1)	0.84(21.3)
3/4	1/2	-WDC-FT12-BW8	1.99(50.5)	0.96(24.4)	1.13(28.6)	1.06(27.0)	0.55(14.0)	0.75(19.1)	0.84(21.3)
3/4	3/4	-WDC-FT12-BW12	1.99(50.5)	0.96(24.4)	1.10(28.0)	1.06(27.0)	0.62(15.7)	0.75(19.1)	1.05(26.7)
1	1	-WDC-FT16-BW16	2.45(62.2)	1.23(31.2)	1.50(38.1)	1.37(34.9)	0.88(22.4)	0.94(23.9)	1.31(33.4)
1 1/4	1 1/4	-WDC-FT20-BW20	3.04(77.2)	1.62(41.1)	1.87(47.6)	1.75(44.5)	1.09(27.7)	0.94(23.9)	1.66(42.2)
1 1/2	1 1/2	-WDC-FT24-BW24	3.50(88.9)	1.97(50.0)	2.25(57.2)	2.13(54.0)	1.34(34.0)	1.03(26.2)	1.90(48.3)

Weld Connectors

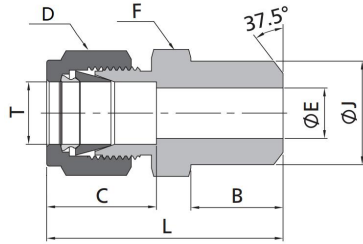

Metric Tube to Pipe Butt Weld

T-Tube O.D.(mm)	Pipe Weld SIZE	Basic Ordering Number	Dimension,mm(in)						
			L	C	D	F	E	B	J
3	1/8	-WDC-MT3-BW2	30.5(1.20)	12.9(0.51)	12.0(0.47)	12.0(0.47)	2.4(0.09)	9.7(0.38)	10.3(0.41)
4	1/8	-WDC-MT4-BW2	31.5(1.24)	13.7(0.54)	12.0(0.47)	12.0(0.47)	2.4(0.09)	9.7(0.38)	10.3(0.41)
6	1/8	-WDC-MT6-BW2	32.8(1.29)	15.3(0.60)	14.0(0.55)	14.0(0.55)	4.8(0.19)	9.7(0.38)	10.3(0.41)
6	1/4	-WDC-MT6-BW4	37.9(1.49)	15.3(0.60)	14.0(0.55)	14.0(0.55)	4.8(0.19)	14.2(0.56)	13.7(0.54)
8	1/8	-WDC-MT8-BW2	34.2(1.35)	16.2(0.64)	16.0(0.63)	15.0(0.59)	5.4(0.21)	9.7(0.38)	10.3(0.41)
8	1/4	-WDC-MT8-BW4	38.7(1.52)	16.2(0.64)	16.0(0.63)	15.0(0.59)	6.4(0.25)	14.2(0.56)	13.7(0.54)
8	1/2	-WDC-MT8-BW8	45.6(1.80)	16.2(0.64)	16.0(0.63)	22.0(0.87)	6.4(0.25)	19.1(0.75)	21.3(0.84)
10	1/4	-WDC-MT10-BW4	40.9(1.60)	17.2(0.70)	19.0(0.75)	18.0(0.71)	7.5(0.30)	14.2(0.56)	13.7(0.54)
10	3/8	-WDC-MT10-BW6	40.9(1.60)	17.2(0.70)	19.0(0.75)	18.0(0.71)	7.9(0.31)	14.2(0.56)	17.1(0.67)
10	1/2	-WDC-MT10-BW8	46.5(1.80)	17.2(0.70)	19.0(0.75)	22.0(0.87)	7.9(0.31)	19.1(0.75)	21.3(0.84)
12	1/4	-WDC-MT12-BW4	43.4(1.70)	22.8(0.90)	22.0(0.87)	22.0(0.87)	7.5(0.30)	14.2(0.56)	13.7(0.54)
12	3/8	-WDC-MT12-BW6	43.4(1.70)	22.8(0.90)	22.0(0.87)	22.0(0.87)	9.5(0.37)	14.2(0.56)	17.1(0.67)
12	1/2	-WDC-MT12-BW8	49.0(1.90)	22.8(0.90)	22.0(0.87)	22.0(0.87)	9.5(0.37)	19.1(0.75)	21.3(0.84)
14	3/8	-WDC-MT14-BW6	44.1(1.70)	24.4(1.00)	25.0(0.98)	24.0(0.94)	10.7(0.42)	14.2(0.56)	17.1(0.67)
15	1/2	-WDC-MT15-BW8	49.0(1.90)	24.4(1.00)	25.0(0.98)	24.0(0.94)	11.9(0.47)	19.1(0.75)	21.3(0.84)
16	1/2	-WDC-MT16-BW8	49.0(1.90)	24.4(1.00)	25.0(0.98)	24.0(0.94)	12.7(0.50)	19.1(0.75)	21.3(0.84)
18	1/2	-WDC-MT18-BW8	50.5(2.00)	24.4(1.00)	30.0(1.18)	27.0(1.06)	13.9(0.55)	19.1(0.75)	21.3(0.84)
30	1 1/4	-WDC-MT30-BW20	77.2(3.00)	39.6(1.60)	50.0(1.97)	46.0(1.81)	26.2(1.03)	23.9(0.94)	42.2(1.66)
32	1 1/4	-WDC-MT32-BW20	79.6(3.10)	42.0(1.70)	50.0(1.97)	46.0(1.81)	28.6(1.13)	23.9(0.94)	42.2(1.66)
38	1 1/2	-WDC-MT38-BW24	91.6(3.60)	49.4(1.90)	60.0(2.36)	55.0(2.17)	33.7(1.33)	26.2(1.03)	48.3(1.9)

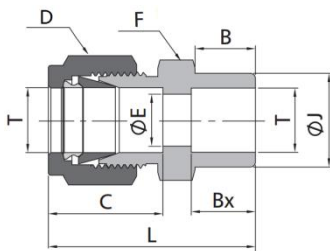

Metric Tube to Tube Socket Weld

T-Tube O.D.(mm)	Basic Ordering Number	Dimension,mm(in)							
		L	C	D	F	B	E	Bx	J
1/8	-WDC-FT2-SW2	1.14(29.0)	0.50(12.7)	0.44(11.1)	0.44(11.1)	0.34(8.6)	0.09(2.3)	0.10(2.5)	0.31(7.9)
3/16	-WDC-FT3-SW3	1.17(29.7)	0.54(13.7)	0.50(12.7)	0.44(11.1)	0.37(9.5)	0.13(3.3)	0.19(4.8)	0.42(10.7)
1/4	-WDC-FT4-SW4	1.32(33.5)	0.60(15.2)	0.56(14.3)	0.50(12.7)	0.41(10.4)	0.19(4.8)	0.28(7.1)	0.44(11.2)
3/8	-WDC-FT6-SW6	1.48(37.6)	0.66(16.8)	0.69(17.5)	0.63(15.9)	0.47(11.9)	0.28(7.1)	0.31(7.9)	0.62(15.7)
1/2	-WDC-FT8-SW8	1.62(41.1)	0.90(22.9)	0.87(22.2)	0.81(20.6)	0.47(11.9)	0.41(10.4)	0.38(9.7)	0.75(19.1)
5/8	-WDC-FT10-SW10	1.65(41.9)	0.96(24.4)	1.00(25.4)	0.94(23.8)	0.47(11.9)	0.50(12.7)	0.41(10.4)	0.92(23.4)
3/4	-WDC-FT12-SW12	1.71(43.4)	0.96(24.4)	1.13(28.6)	1.06(27.0)	0.47(11.9)	0.62(15.7)	0.44(11.1)	1.05(26.7)
1	-WDC-FT16-SW16	2.07(52.6)	1.23(31.2)	1.50(38.1)	1.37(34.9)	0.56(14.2)	0.88(22.4)	0.62(15.7)	1.31(33.3)

Weld Elbows

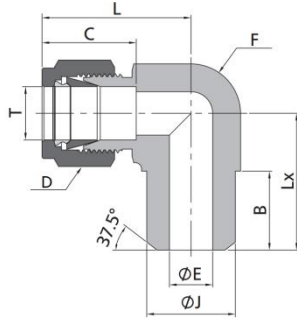

Fractional Tube to Pipe Butt Weld

T-Tube O.D.(in.)	Pipe Weld SIZE	Basic Ordering Number	Dimension,in(mm)							
			L	C	D	F	B	E	Lx	J
1/8	1/8	-WDE-FT2-BW2	0.92(23.4)	0.50(12.7)	0.44(11.1)	0.44(11.1)	0.38(9.7)	0.09(2.3)	0.72(18.3)	0.41(10.3)
3/16	1/8	-WDE-FT3-BW2	1.01(25.7)	0.54(13.7)	0.50(12.7)	0.50(12.7)	0.38(9.7)	0.13(3.3)	0.74(18.8)	0.41(10.3)
1/4	1/8	-WDE-FT4-BW2	1.06(26.9)	0.60(15.2)	0.56(14.3)	0.50(12.7)	0.38(9.7)	0.19(4.8)	0.74(18.8)	0.41(10.3)
1/4	1/4	-WDE-FT4-BW4	1.06(26.9)	0.60(15.2)	0.56(14.3)	0.50(12.7)	0.56(14.2)	0.19(4.8)	0.92(23.4)	0.54(13.7)
3/8	1/4	-WDE-FT6-BW4	1.20(30.5)	0.66(16.8)	0.69(17.5)	0.63(15.9)	0.56(14.2)	0.28(7.1)	1.00(25.4)	0.54(13.7)
1/2	3/8	-WDE-FT8-BW6	1.37(34.8)	0.90(22.9)	0.87(22.2)	0.75(19.1)	0.56(14.2)	0.41(10.4)	1.13(28.8)	0.67(17.1)
1/2	1/2	-WDE-FT8-BW8	1.42(36.1)	0.90(22.9)	0.87(22.2)	0.81(20.6)	0.75(19.1)	0.41(10.4)	1.30(33.0)	0.84(21.3)
5/8	1/2	-WDE-FT10-BW8	1.57(39.9)	0.96(24.4)	1.00(25.4)	0.94(23.8)	0.75(19.1)	0.50(12.7)	1.38(35.1)	0.84(21.3)
3/4	3/4	-WDE-FT12-BW12	1.94(49.3)	0.96(24.4)	1.13(28.6)	1.06(27.0)	0.75(19.1)	0.62(15.7)	1.45(36.8)	1.05(26.7)
1	3/4	-WDE-FT16-BW12	1.94(49.3)	1.23(31.2)	1.50(38.1)	1.37(34.9)	0.75(19.1)	0.88(22.4)	1.65(41.9)	1.05(26.7)
1	1	-WDE-FT16-BW16	1.94(49.3)	1.23(31.2)	1.50(38.1)	1.37(34.9)	0.81(20.6)	0.88(22.4)	1.84(46.7)	1.31(33.4)

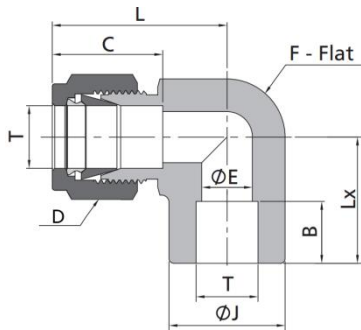

Fractional Tube to Tube Socket Weld

T-Tube O.D.(in.)	Basic Ordering Number	Dimension,in(mm)							
		L	C	D	F	B	E	Lx	J
1/8	-WDE-FT2-BW2	0.66(16.8)	0.50(12.7)	0.44(11.1)	0.37(9.5)	0.10(2.5)	0.09(2.3)	0.63(16.0)	0.38(9.7)
3/16	-WDE-FT3-BW3	0.72(18.3)	0.54(13.7)	0.50(12.7)	0.44(11.1)	0.19(4.8)	0.13(3.3)	0.69(17.5)	0.44(11.2)
1/4	-WDE-FT4-BW4	1.06(26.9)	0.60(15.2)	0.56(14.3)	0.50(12.7)	0.28(7.1)	0.19(4.8)	0.77(19.6)	0.50(12.7)
3/8	-WDE-FT6-BW6	1.20(30.5)	0.66(16.8)	0.69(17.5)	0.63(15.9)	0.31(7.9)	0.28(7.1)	0.91(23.1)	0.62(15.7)
1/2	-WDE-FT8-BW8	1.42(36.1)	0.90(22.9)	0.87(22.2)	0.81(20.6)	0.38(9.7)	0.41(10.4)	1.02(25.9)	0.81(20.6)
5/8	-WDE-FT10-BW10	1.16(29.5)	0.96(24.4)	1.00(25.4)	1.06(27.0)	0.41(10.4)	0.50(12.7)	1.16(29.5)	0.94(23.9)
3/4	-WDE-FT12-BW12	1.57(39.9)	0.96(24.4)	1.13(28.6)	1.06(27.0)	0.44(11.2)	0.62(15.7)	1.17(29.7)	1.06(26.9)
1	-WDE-FT16-BW16	1.93(49.0)	1.23(31.2)	1.50(38.1)	1.37(34.9)	0.62(15.7)	0.88(22.4)	1.45(36.8)	1.38(35.1)

Vents Protectors

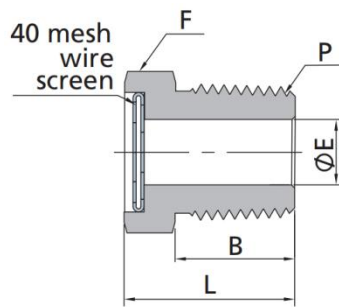

T-Tube O.D. (in.)	Basic Ordering Number	Dimension, in. (mm)			
		L	C	E	D
1/8	-VP-MN2	0.56(14.2)	0.50(12.7)	0.38(9.7)	0.19(4.8)
1/4	-VP-MN4	0.78(19.8)	0.56(14.3)	0.56(14.2)	0.28(7.1)
3/8	-VP-MN6	0.81(20.6)	0.69(17.5)	0.56(14.2)	0.41(10.4)
1/2	-VP-MN8	1.03(26.2)	0.87(22.2)	0.75(19.1)	0.50(12.7)
3/4	-VP-MN12	1.06(26.9)	1.06(27.0)	0.76(19.2)	0.72(18.3)
1	-VP-MN16	1.37(34.8)	1.37(34.9)	0.94(23.9)	0.88(22.4)

Lapped Flange Connectors

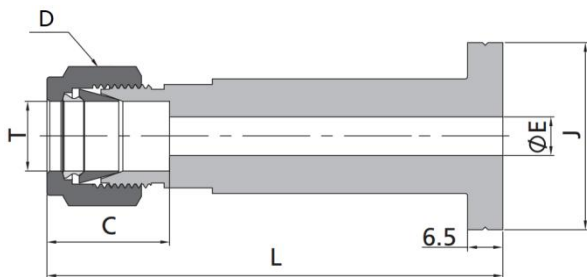

Fractional Tube							
T-Tube O.D.(in.)	Flange Seal	Basic Ordering Number	Dimension, in. (mm)				
			L	D	C	E	J
1/4	A	-LFC-FT4A	3.18(80.8)	0.56(14.3)	0.60(15.2)	0.60(15.2)	1.36(34.5)
1/4	B	-LFC-FT4B	3.18(80.8)	0.56(14.3)	0.60(15.2)	0.19(4.8)	1.36(34.5)
3/8	A	-LFC-FT6A	3.26(82.9)	0.69(17.5)	0.66(16.8)	0.28(7.1)	1.36(34.5)
3/8	B	-LFC-FT6B	3.26(82.9)	0.69(17.5)	0.66(16.8)	0.28(7.1)	1.36(34.5)
1/2	A	-LFC-FT8A	3.35(85.1)	0.87(22.2)	0.90(22.9)	0.31(7.9)	1.36(34.5)
1/2	B	-LFC-FT8B	3.35(85.1)	0.87(22.2)	0.90(22.9)	0.31(7.9)	1.36(34.5)

Metric Tube							
T-Tube O.D.(mm)	Flange Seal	Basic Ordering Number	Dimension,mm (in.)				
			L	D	C	E	J
10	A	-LFC-MT10A	82.6(3.25)	19.0(0.75)	17.2(0.68)	7.9(0.31)	34.5(1.36)
10	B	-LFC-MT10B	82.6(3.25)	19.0(0.75)	17.2(0.68)	7.9(0.31)	34.5(1.36)

Flange Adaptors

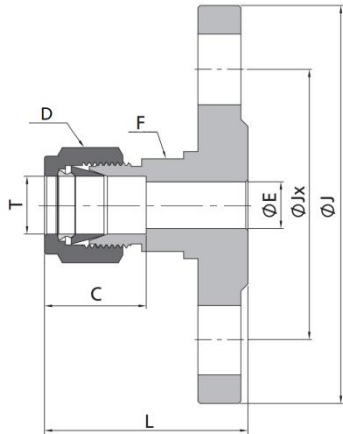

Fractional Tube to ANSI Flanges B16.5

T-Tube O.D. (in.)	ANSI Flange NPS	Class	Basic Ordering Number Raised Face Flange	Dimension, in. (mm)						
				L	J	Jx	E	C	G	F
1/4	1/2	150	-FGA-FT4-F8-150	1.61(40.9)	3.50(88.9)	2.38(60.5)	0.19(4.8)	0.60(15.2)	0.56(14.3)	0.81(20.6)
3/8	1/2	300	-FGA-FT6-F8-300	1.79(45.5)	3.75(95.3)	2.62(66.5)	0.28(7.1)	0.66(16.8)	0.69(17.5)	0.81(20.6)
1/2	1/2	150	-FGA-FT8-F8-150	1.78(45.2)	3.50(88.9)	2.38(60.5)	0.41(10.4)	0.90(22.9)	0.87(22.2)	0.81(20.6)
1/2	1	150	-FGA-FT8-F16-150	1.90(48.3)	4.25(108.0)	3.12(79.2)	0.41(10.4)	0.90(22.9)	0.87(22.2)	0.81(20.6)
1/2	2	150	-FGA-FT8-F32-150	2.09(53.1)	6.00(152.4)	4.76(121.0)	0.41(10.4)	0.90(22.9)	0.87(22.2)	0.81(20.6)
3/4	1	150	-FGA-FT12-F16-150	1.98(50.3)	4.25(108.0)	3.12(79.2)	0.62(15.7)	0.96(24.4)	1.13(28.6)	1.25(31.8)
1	1	150	-FGA-FT16-F16-150	2.38(60.5)	4.25(108.0)	3.12(79.2)	0.88(22.4)	1.23(31.2)	1.50(38.1)	1.37(34.9)

Fractional Tube to DIN Flanges PN40

T-Tube O.D. (mm)	DIN Flange Size DN	Basic Ordering Number Raised Face Flange	Dimension, in. (mm)						
			L	J	Jx	E	C	G	F
6	25	-FGA-MT6-F25-40P	47.5(1.87)	115.0(4.53)	85.0(3.35)	4.8(0.19)	15.3(0.60)	14.0(0.55)	20.0(0.79)
12	15	-FGA-MT12-F15-40P	48.5(1.91)	95.0(3.74)	65.0(2.56)	9.5(0.37)	22.8(0.90)	22.0(0.87)	20.0(0.79)
12	25	-FGA-MT12-F25-40P	50.5(1.99)	115.0(4.53)	85.0(3.35)	9.5(0.37)	22.8(0.90)	22.0(0.87)	20.0(0.79)
12	50	-FGA-MT12-F50-40P	55.3(2.18)	165.0(6.50)	125.0(4.92)	9.5(0.37)	22.8(0.90)	22.0(0.87)	20.0(0.79)
18	15	-FGA-MT18-F15-40P	51.8(2.04)	95.0(3.74)	65.0(2.56)	15.1(0.59)	24.4(0.96)	30.0(1.18)	32.0(1.26)
18	25	-FGA-MT18-F25-40P	53.8(2.12)	115.0(4.53)	85.0(3.35)	15.1(0.59)	24.4(0.96)	30.0(1.18)	32.0(1.26)
25	25	-FGA-MT25-F25-40P	64.0(2.52)	115.0(4.53)	85.0(3.35)	21.8(0.86)	31.3(1.23)	38.0(1.50)	35.0(1.38)

Fractional Tube to JIS Flanges 10K

T-Tube O.D.(in.)	JIS Flange Size DN	Basic Ordering Number Raised Face Flange	Dimension, in. (mm)						
			L	J	Jx	E	C	G	F
1/4"	15	-FGA-FT4-F15-10K	1.66(42.2)	3.74(95.0)	2.76(70.1)	0.19(4.8)	0.60(15.2)	0.56(14.3)	0.81(20.6)
3/8"	15	-FGA-FT6-F15-10K	1.72(43.7)	3.74(95.0)	2.76(70.1)	0.28(7.1)	0.66(16.8)	0.69(17.5)	0.81(20.6)
1/2"	15	-FGA-FT8-F15-10K	1.83(46.5)	3.74(95.0)	2.76(70.1)	0.41(10.4)	0.90(22.9)	0.87(22.2)	0.81(20.6)
3/4"	15	-FGA-FT12-F15-10K	1.91(48.5)	3.74(95.0)	2.76(70.1)	0.62(15.7)	0.96(24.4)	1.13(28.6)	1.25(31.8)
1"	25	-FGA-FT16-F25-10K	2.40(61.0)	4.92(125.0)	3.54(89.9)	0.88(22.4)	1.23(31.2)	1.50(38.1)	1.37(34.9)
12mm	15	-FGA-FT12-F15-10K	1.83(46.5)	3.74(95.0)	2.76(70.0)	0.37(9.5)	0.90(22.8)	0.87(22.0)	0.79(20.0)
18mm	15	-FGA-FT18-F15-10K	1.91(48.5)	3.74(95.0)	2.76(70.0)	0.59(15.1)	0.96(24.4)	1.18(30.0)	1.26(32.0)
25mm	25	-FGA-FT25-F25-10K	2.40(61.0)	4.92(125.0)	3.54(90.0)	0.86(21.8)	1.23(31.3)	1.50(38.0)	1.38(35.0)

61 Tube Fittings

Nuts

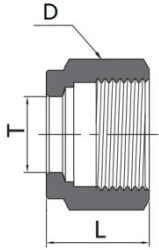

Fractional Tube				Metric Tube			
T-Tube O.D.(in.)	Basic Ordering Number	Dimension, in. (mm)		T-Tube O.D.(mm)	Basic Ordering Number	Dimension, mm(In.)	
		D	L			D	L
1/16	-TN-FT1	0.31(7.9)	0.31(7.9)	2	-TN-MT2	12.0(0.47)	11.9(0.47)
1/8	-TN-FT2	0.44(11.1)	0.47(11.9)	3	-TN-MT3	12.0(0.47)	11.9(0.47)
3/16	-TN-FT3	0.50(12.7)	0.47(11.9)	4	-TN-MT4	12.0(0.47)	11.9(0.47)
1/4	-TN-FT4	0.56(14.3)	0.50(12.7)	6	-TN-MT6	14.0(0.55)	12.7(0.50)
5/16	-TN-FT5	0.63(15.9)	0.53(13.5)	8	-TN-MT8	16.0(0.63)	13.5(0.53)
3/8	-TN-FT6	0.69(17.5)	0.56(14.2)	10	-TN-MT10	19.0(0.75)	15.1(0.59)
1/2	-TN-FT8	0.87(22.2)	0.69(17.5)	12	-TN-MT12	22.0(0.87)	17.4(0.69)
5/8	-TN-FT10	1.00(25.4)	0.69(17.5)	14	-TN-MT14	25.0(0.98)	17.4(0.69)
3/4	-TN-FT12	1.13(28.6)	0.69(17.5)	15	-TN-MT15	25.0(0.98)	17.4(0.69)
7/8	-TN-FT14	1.25(31.8)	0.69(17.5)	16	-TN-MT16	25.0(0.98)	17.4(0.69)
1	-TN-FT16	1.50(38.1)	0.81(20.6)	18	-TN-MT18	30.0(1.18)	17.4(0.69)
1 1/8	-TN-FT18	1.81(46.0)	1.21(30.8)	20	-TN-MT20	32.0(1.26)	17.4(0.69)
1 1/4	-TN-FT20	1.87(47.6)	1.25(31.8)	22	-TN-MT22	32.0(1.26)	17.4(0.69)
1 1/2	-TN-FT24	2.25(57.2)	1.50(38.1)	25	-TN-MT25	38.0(1.50)	20.6(0.81)
				28	-TN-MT28	46.0(1.81)	30.6(1.20)
				30	-TN-MT30	50.0(1.97)	32.7(1.29)
				32	-TN-MT32	50.0(1.97)	34.4(1.35)
				38	-TN-MT38	60.0(2.36)	40.6(1.60)

Frant Ferrules

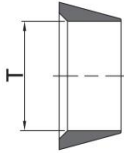

Rear Ferrules

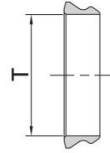

Fractional Tube		Metric Tube		Fractional Tube		Metric Tube	
T-Tube O.D.(in.)	Basic Ordering Number	T-Tube O.D.(mm)	Basic Ordering Number	T-Tube O.D.(in.)	Basic Ordering Number	T-Tube O.D.(mm)	Basic Ordering Number
1/16	-FF-FT1	2	-FF-MT2	1/16	-RF-FT1	2	-RF-MT2
1/8	-FF-FT2	3	-FF-MT3	1/8	-RF-FT2	3	-RF-MT3
3/16	-FF-FT3	4	-FF-MT4	3/16	-RF-FT3	4	-RF-MT4
1/4	-FF-FT4	6	-FF-MT6	1/4	-RF-FT4	6	-RF-MT6
5/16	-FF-FT5	8	-FF-MT8	5/16	-RF-FT5	8	-RF-MT8
3/8	-FF-FT6	10	-FF-MT10	3/8	-RF-FT6	10	-RF-MT10
1/2	-FF-FT8	12	-FF-MT12	1/2	-RF-FT8	12	-RF-MT12
5/8	-FF-FT10	14	-FF-MT14	5/8	-RF-FT10	14	-RF-MT14
3/4	-FF-FT12	15	-FF-MT15	3/4	-RF-FT12	15	-RF-MT15
7/8	-FF-FT14	16	-FF-MT16	7/8	-RF-FT14	16	-RF-MT16
1	-FF-FT16	18	-FF-MT18	1	-RF-FT16	18	-RF-MT18
1 1/8	-FF-FT18	20	-FF-MT20	1 1/8	-RF-FT18	20	-RF-MT20
1 1/4	-FF-FT20	22	-FF-MT22	1 1/4	-RF-FT20	22	-RF-MT22
1 1/2	-FF-FT24	25	-FF-MT25	1 1/2	-RF-FT24	25	-RF-MT25
		28	-FF-MT28			28	-RF-MT28
		30	-FF-MT30			30	-RF-MT30
		32	-FF-MT32			32	-RF-MT32
		38	-FF-MT38			38	-RF-MT38

Nuts+Ferrules

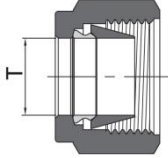

Fractional Tube		Metric Tube	
T-Tube O.D.(in.)	Basic Ordering Number	T-Tube O.D.(mm)	Basic Ordering Number
1/16	-NF-FT1	2	-NF-MT2
1/8	-NF-FT2	3	-NF-MT3
3/16	-NF-FT3	4	-NF-MT4
1/4	-NF-FT4	6	-NF-MT6
5/16	-NF-FT5	8	-NF-MT8
3/8	-NF-FT6	10	-NF-MT10
1/2	-NF-FT8	12	-NF-MT12
5/8	-NF-FT10	14	-NF-MT14
3/4	-NF-FT12	15	-NF-MT15
7/8	-NF-FT14	16	-NF-MT16
1	-NF-FT16	18	-NF-MT18
1 1/8	-NF-FT18*	20	-NF-MT20
1 1/4	-NF-FT20*	22	-NF-MT22
1 1/2	-NF-FT24*	25	-NF-MT25
		28	-NF-MT28*
		30	-NF-MT30*
		32	-NF-MT32*
		38	-NF-MT38*

Male Nuts

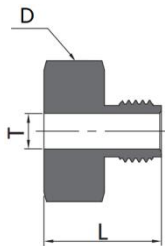

Fractional Tube				Metric Tube			
T-Tube O.D.(in.)	Basic Ordering Number	Dimension, in. (mm)		T-Tube O.D.(mm)	Basic Ordering Number	Dimension, mm(In.)	
		D	L			D	L
1/16	-TMN-FT1	0.25(6.4)	0.38(9.7)	3	-TMN-MT3	10.0(0.39)	13.5(0.53)
1/8	-TMN-FT2	0.37(9.5)	0.53(13.5)	6	-TMN-MT6	14.0(0.55)	15.7(0.62)
1/4	-TMN-FT4	0.50(12.7)	0.62(15.7)	10	-TMN-MT10	22.0(0.87)	22.1(0.87)
1/2	-TMN-FT8	0.94(23.8)	0.87(22.1)	12	-TMN-MT12	24.0(0.94)	22,1(0.87)

Chromatograph Straight Fittings

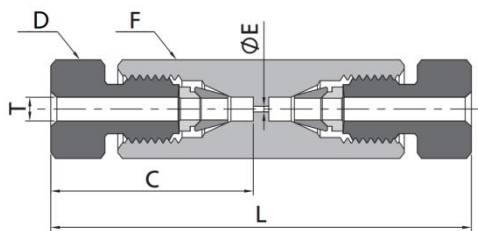

Fractional Tube

T-Tube O.D. (in.)	Basic Ordering Number	Dimension, in. (mm)					Dead Volume
		L	C	E	D	F	
1/16	-CF-FT1	1.26(32.0)	0.61(15.5)	0.01(0.3)	0.25(6.4)	0.25(6.4)	$6.6 \times 10^{-5} \text{cm}^3$

Chromatograph Tee Fittings

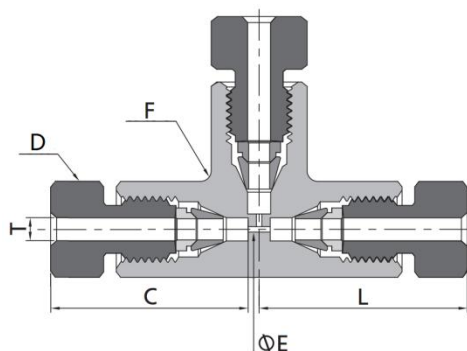

Fractional Tube

T-Tube O.D. (in.)	Basic Ordering Number	Dimension, in. (mm)					Dead Volume
		L	C	E	D	F	
1/16	-CFT-FT1	0.66(16.8)	0.61(15.5)	0.01(0.3)	0.25(6.4)	0.37(9.5)	$6.6 \times 10^{-4} \text{cm}^3$

Nantong ROKE Fluid Equipment Co.,LTD

ROKE Factory

Pingchao Town, Tongzhou Area
Nantong City, Jiangsu Province,China
Tel :86-513-86751377
Fax:86-513-86752577

ROKE Office

Room 1108 .Building B. Jianghaicaifudasha
No.817.Jianghai Avenue.Gangzha Area
Nantong City, Jiangsu Province,China
Tel: 86-513-85400443
Fax:86-513-85400444
Web:www.chinaroke.com
E-mail:sales01@ntroke.com

ROKE
Valves and Fittings

www.chinaroke.com